

Singer 7-31

Singer 7-33

Singer 7-41

Form 18275, Revised
(640)
Printed in U. S. A.

LIST OF PARTS



MACHINES
Nos. 7-31, 7-33 and 7-41

INSTRUCTIONS FOR OILING

To ensure easy running and prevent unnecessary wear of the parts which are in movable contact, the machine requires oiling and when in continuous use, "TYPE B" or "TYPE D" OIL, sold only by Singer Sewing Machine Company, should be applied at least twice each day to all oil holes marked "OIL", as instructed in Form 8183.

Copyright, U. S. A., 1918, 1928 and 1940
by The Singer Manufacturing Co.
All Rights Reserved for all Countries

INDEX

	Page
Accessories.....	14
Belt Shifter Parts for No. 7-41 Machine.....	14
Bobbin Winders.....	15 to 17
Driving Attachment for No. 7-31 Machine.....	18
Driving Attachment for No. 7-31 Machine, obsolete.....	19
Iron Work for No. 5283.....	21
Iron Work for No. 5376.....	21
Numerical List of Parts.....	39
Obsolete Parts.....	33
Machine No. 7-31.....	13
Machine No. 7-33.....	13
Machine No. 7-41.....	13
Stand (Rocking Treadle) for No. 7-33 Machine.....	23
Stand (Rotary Treadle) for No. 7-33 Machine.....	24
Steel Work for Nos. 29707, 29708 and 29712.....	26
Steel Work for No. 29711, for S.A. No. 5410 Motor.....	25
Steel Work for No. 29711 with S.D.A.....	27
Steel Work for No. 29710.....	28
Table Belt Guide for No. 29711, for No. 7-31 Machine...	32
Thread Unwinder for No. 5201, for No. 25207.....	32
Under Driver Parts.....	30

From the library of
The Singer Sewing Machine Company

INSTRUCTIONS FOR ORDERING

In ordering from this list, use ONLY the part NUMBER in the FIRST column.

The number stamped on a Sewing Machine Part is in every case the number of the single part only.

Every combination of parts sent out as such has its specific number, which, although not stamped on the parts, must be used when ordering the combination.

Each number always indicates the SAME PART in whatever list it appears, or for whatever machine.

The letters after some of the numbers indicate the style of finish only, as follows:

- A-Hardened, Polished, Nickel Plated and Buffed
- A.A-Buffed and Chromium Plated
- A.B-Hardened, Polished, Buffed and Chromium Plated
- A.C-Brown Baking Enamel Finish
- A.D-Gray Baking Enamel Finish
- A.E-Hardened, Bright Rumbled and Nickel Plated
- A.F-Hardened, Bright Rumbled, Nickel Plated, Bright Rumbled and Chromium Plated
- B-Polished, Nickel Plated and Buffed
- C-Hardened Only
- C.R-Hardened and Merlized
- D-Polished Only
- E-Soft, Not Polished
- F-Hardened and Polished
- F.J-Hardened, Polished and Nickel Plated
- G-Bright Rumbled and Nickel Plated
- H-Blued
- J-Nickel Plated Only
- K-Hardened and Nickel Plated
- L-Brass Plated
- M-Oxidized
- N-Japaned, Dull
- P-Japaned, Bright
- P.P-Wrinkle Finish
- R-Merlized
- S-Cadmium Plated
- T-Copper Plated
- T.A-Hardened, Polished, Copper and Nickel Plated and Buffed
- T.B-Copper and Nickel Plated and Polished
- T.J-Copper and Nickel Plated Only
- T.K-Hardened, Copper and Nickel Plated
- T.L-Copper and Brass Plated
- T.M-Copper Plated and Oxidized
- U-Zinc Plated
- V-Silver Plated
- W-Polished and Nickel Plated
- X-Black Oxide, for Iron and Steel
- X.C-Hardened and Black Oxide, for Iron or Steel
- Y-Black Nickel Plated Only
- Z-Chromium Plated
- Z.A-Hardened, Polished, Nickel Plated, Buffed and Chromium Plated
- Z.B-Polished, Nickel Plated, Buffed and Chromium Plated
- Z.C-Hardened and Chromium Plated
- Z.D-Polished and Chromium Plated
- Z.G-Bright Rumbled, Nickel Plated, Bright Rumbled and Chromium Plated
- Z.J-Nickel and Chromium Plated
- Z.T-Copper and Chromium Plated

These letters MUST BE USED when they appear in the list; and AFTER the number as in the list.

In this series:
 1 to 1500, 50001 to 51500 and 140001 to 142000 are Screw Numbers
 1501 to 1800 and 51501 to 51800 are Nut Numbers
 1801 to 2000 and 51801 to 52000 are Roller Numbers
 2001 to 50000 and 52001 to 140000 and 142001 to 190000 are Sewing Machine Parts, 190001 and upward are numbers of Electrical Parts.

The figures in the second column refer only to the plates, illustrating the parts, and are NOT TO BE USED in ordering.

Parts marked with an asterisk (*) are furnished only when repairs are made at factory.

LIST OF PARTS COMPLETE

FOR

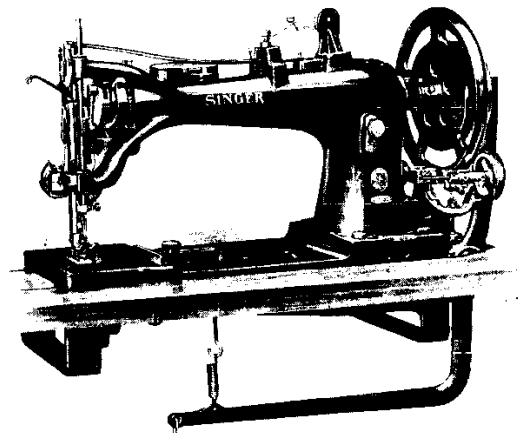

MACHINE No. 7-31

Heavy Work in Canvas. Length of stitch 2 to 8 to the inch.
 Clearance under presser foot 9/16 inch. Alternating pressers.
 S. D. A. Speed up to 550, according to the material being stitched.

No.	Plate	Name
*58257	-----	Arm with 15404 and two 15405.....
8702	4475	" Dowel Pin.....
872E	4479	" Screw.....
58648	22798	" Shaft.....
11354	4463	" " Bushing.....
437C	4478	" " " Set Screw.....
949E	22796	" " " Screw.....
49095	22796	" " " Washer.....
11913	4462	" Side Cover.....
65D	4477	" " " Hinge Screw.....
58649	22798	Balance Wheel with two 354C.....
58650	-----	" " 58649 with 58657, 122469, two 1402D and four 401J.....
25362	7978	Balance Wheel Ball, size 3/16 in.....
58651	22796	" " " Ring with eighteen 25362.....

From the library of: Diamond Needle Corp

No.	Plate	Name
58652	22796	Balance Wheel Ball Washer (left).....
122469	22796	" " " " (right).....
1402D	7871	" " " " " Screw.
58657	22796	" " Friction Washer (paper)...
401J	4476	" " " " " Screw.....
354C	4479	" " Set Screw.....
*19832	-----	Bed.....
58222	4462	Cloth Plate with four 58221, for 19855..
58221	-----	" " Packing Rivet.....
389F	4476	" " Screw.....
19758	4462	Crank Connecting Rod with two 575E.....
575E	4476	" " " Cap Screw.....
1151C	4476	" " " Hinge Screw.....
1646E	4479	" " " " " Nut....
11365	4464	Feed Bar.....
50359C	4478	" " Screw Center.....
1513J	4479	" " " " Nut.....
11367	4463	" Cam with two 445C.....
445C	4478	" " Set Screw.....
11368	4465	" Connecting Link.....
565C	4476	" " " Hinge Screw.....
1513J	4479	" " " " " Nut....
19834	4436	" Dog (double).....
19835	4437	" " (single).....
166D	4476	" " Screw.....
19762	4461	" Forked Connection.....
565C	4476	" " " Hinge Screw.....
1513J	4479	" " " " " Nut..
9225	4461	" Lifting Rock Shaft with 134D, 2022 and 19967.....
58288	-----	Feed Lifting Rock Shaft complete, Nos. 9225 and 19837.....
19837	4463	Feed Lifting Rock Shaft Crank with 692D and 1861.....
692D	4479	Feed Lifting Rock Shaft Crank Clamping Screw.....
1861	4475	Feed Lifting Rock Shaft Crank Roller and Stud.....
1015C	4478	Feed Lifting Rock Shaft Screw Center (left).....
1503E	4478	Feed Lifting Rock Shaft Screw Center (left) Nut.....
294C	4478	Feed Lifting Rock Shaft Screw Center (right).....
1503E	4478	Feed Lifting Rock Shaft Screw Center (right) Nut.....
19967	4465	Feed Lifting Rock Shaft Wearing Block...
2022	4465	" " " " " "
		Position Pin.....
134D	4465	Feed Lifting Rock Shaft Wearing Block Screw.....

No.	Plate	Name
11375	4464	Feed Regulator.....
568E	4477	" " Hinge Screw.....
50322D	4477	" " Thumb Screw.....
58243	4461	" Rock Shaft.....
58244	-----	Feed Rock Shaft complete, Nos. 58235 and 58243.....
58235	4465	Feed Rock Shaft Crank with 346E.....
346E	4465	" " " " Clamping Screw....
1015C	4478	" " " " Screw Center (left).....
1503E	4478	" " " " " " Nut.
294C	4478	" " " " " " (right)....
1503E	4478	" " " " " " Nut.
36114	4466	Guide (6 in. face) for 19855.....
26419	4463	" (6 in. face) for 19858.....
885D	4477	" Thumb Screw.....
58258	4464	Lifting Presser Bar.....
58617	22797	" " " Bell Crank.....
58618	22796	" " " " " Hinge Stud
50083C	22796	" " " " " " "
		Set Screw.....
58619	22796	Lifting Presser Bar Bell Crank Slide Block.....
58621	-----	Lifting Presser Bar Bell Crank Slide Block 58619 with 610D.....
610D	4465	Lifting Presser Bar Bell Crank Slide Block Screw.....
1518E	4465	Lifting Presser Bar Bell Crank Slide Block Screw Nut.....
2718	4465	Lifting Presser Bar Bell Crank Slide Block Screw Nut Washer.....
58643	22797	Lifting Presser Bar Bracket with two 145E.....
145E	4473	Lifting Presser Bar Bracket Clamping Screw.....
11909	4464	Lifting Presser Bar Lifter with 8761 and 8763.....
8760	4465	Lifting Presser Bar Lifter Friction Washer.....
16D	4477	Lifting Presser Bar Lifter Hinge Screw..
8761	4465	" " " " Stop Pin.....
11907	4463	" " " " Lifting Link.....
166D	4476	" " " " " Cap Screw
8763	4465	" " " " " Hinge
		Stud.....
8973	4465	Lifting Presser Bar Lifting Link Hinge Stud Pin.....
43267	4465	Lifting Presser Bar Lifting Link Hinge Stud Washer.....
11479	4466	Lifting Presser Bar Rock Shaft.....
58578	22796	" " " " " Adjusting Arm with 453C.....

No.	Plate	Name
2117	4475	Lifting Presser Bar Rock Shaft Adjusting Arm Pin.....
453C	4466	Lifting Presser Bar Rock Shaft Adjusting Arm Set Screw.....
11481	4463	Lifting Presser Bar Rock Shaft Bracket..
2002	4475	" " " " " "
		Dowel Pin (lower).....
4389	4475	Lifting Presser Bar Rock Shaft Bracket Dowel Pin (upper).....
123E	4476	Lifting Presser Bar Rock Shaft Bracket Screw.....
11484	4466	Lifting Presser Bar Rock Shaft Crank with 453C and 1850.....
2117	4475	Lifting Presser Bar Rock Shaft Crank Pin
1850	4466	" " " " " "
		Roller and Stud.....
453C	4466	Lifting Presser Bar Rock Shaft Crank Set Screw.....
11486	850	Lifting Presser Bar Rock Shaft Eccentric Strap with two each 141E and 1528C..
141E	4476	Lifting Presser Bar Rock Shaft Eccentric Strap Adjusting Screw.....
1528C	4479	Lifting Presser Bar Rock Shaft Eccentric Strap Adjusting Screw Nut.....
608C	4466	Lifting Presser Bar Rock Shaft Eccentric Strap Hinge Screw.....
1518D	4465	Lifting Presser Bar Rock Shaft Eccentric Strap Hinge Screw Nut.....
11487	4466	Lifting Presser Bar Rock Shaft Eccentric Strap Hinge Screw Slide.....
58259	4466	Lifting Presser Bar Rock Shaft Eccentric Strap Hinge Screw Slide Stop.....
11488	4466	Lifting Presser Bar Rock Shaft Eccentric Strap Hinge Screw Slide Washer.....
258E	4477	Lifting Presser Bar Screw Bushing.....
11489	4466	" " " Sleeve (lower).....
11490	4466	" " " " (upper).....
11491	-----	" " " " " 11490 with 11492.....
11492	4466	Lifting Presser Bar Sleeve (upper) Cap..
11493	4461	" " " Spring (flat).....
58252	4463	" " " Bracket.....
1177D	4476	" " " " Screw
4389	4475	" " " " Guide Pin....
50323D	4479	" " " " Regulating Thumb Screw.....
58260	4467	Lifting Presser Foot with 1259C, for 19834.....
58261	4467	Lifting Presser Foot with 1259C, for 19835.....

No.	Plate	Name
1259C	4478	Lifting Presser Foot Set Screw.....
11538	4464	Needle Bar.....
11539	4468	" " " " Connecting Link.....
566C	4468	" " " " " Hinge Screw..
1513J	4479	" " " " " " " Nut.....
11383	4468	Needle Bar Connecting Stud with two 445F.....
445F	4478	Needle Bar Connecting Stud Set Screw....
256E	4477	" " " Screw Bushing.....
19702	4468	" " " Clamp with 680F and 11385.....
11385	4468	" " " " " Gib.....
680F	4468	" " " " " Thumb Screw.....
58253	-----	Oil Cup.....
11917	-----	" " " Cover.....
9094	4468	" " " " " Hinge Pin.....
2205	4468	" " " " " Latch Spring.....
207F	4468	" " " " " " Screw.....
8953	4468	Oil or Wax Stripper (felt).....
11918	4468	" " " " " Washer (steel) for 11917.....
8482	4468	Oil or Wax Stripper Washer (steel) for 58253.....
207F	4468	Oil or Wax Stripper Washer Screw.....
58254	4462	Oil Cup complete, Nos. 2205, 8482, 9084, 11917, 11918, 58253, two 8953 and three 207F.....
134D	4465	Oil Cup Screw.....
58550	22797	Oscillating Rock Shaft.....
58558	-----	Oscillating Rock Shaft complete, Nos. 1503J, 11165, 51227C, 58550, 58560 and 58595.....
58552	22796	Oscillating Rock Shaft Hinge Pin.....
58595	-----	" " " " " " 58552 with 1503J.....
1503J	4478	Oscillating Rock Shaft Hinge Pin Nut...
51227C	22796	" " " " " " Screw
		Bearing.....
1503J	4478	Oscillating Rock Shaft Hinge Pin Screw Bearing Nut.....
11165	4469	Oscillating Rock Shaft Oil Pad.....
68350	22796	" " " " " Tube Oil Cup.
58559	22796	" " " " " " with 49191.....
58554	22796	Oscillating Rock Shaft Oil Tube Joint...
49191	22796	" " " " " " Sleeve..
58560	22796	Oscillating Rock Shaft Oil Tube and Joint complete, Nos. 58554, 58559 and 68350.....
19842	4461	Oscillating Shaft.....
9152	4469	" " " Collar with two 448C..

No.	Plate	Name
448C	4469	Oscillating Shaft Collar Set Screw.....
19770	-----	" " Crank with 445C.....
19789	4469	Oscillating Shaft Crank complete, Nos. 1508E, 19770 and 19773.....
9873	4475	Oscillating Shaft Crank Pin.....
445C	4478	" " " Set Screw.....
19771	4469	" " " Slide Block.....
19773	4469	Oscillating Shaft Crank Slide Block com- plete, Nos. 164E, 1156C, 19771 and 19772.....
164E	4469	Oscillating Shaft Crank Slide Block Cap Screw.....
19772	4469	Oscillating Shaft Crank Slide Block Cap Screw Washer.....
1156C	4469	Oscillating Shaft Crank Slide Block Cap Screw Stud.....
1508E	4469	Oscillating Shaft Crank Slide Block Cap Screw Stud Nut.....
16901	3563	Shuttle Bobbin.....
58207	4470	" Cylinder.....
58271	-----	" " 58207 with 1323F and 58209.....
8777	3564	Shuttle Cylinder Hinge Pin.....
58644	22795	" " Latch.....
43236	4471	" " Hinge Pin.....
58666	22795	" " Spring.....
58667	22795	" Frame.....
58668	-----	" " 58667 with 43236, 58644 and 58666.....
1323F	3564	Shuttle Tension Regulating Screw.....
58209	4471	" " Spring.....
58669	22795	Shuttle (cylinder) 4 in. diam., com- plete, Nos. 8777, 16901, 58271, 58668 and 120571.....
120571	22795	Shuttle (cylinder) Opener.....
19845	4472	" Driver with 445C.....
8873	4475	" " Pin.....
445C	4478	" " Set Screw.....
19846	4441	" Race Back.....
2049	4475	" " Position Pin.....
19847	4441	" " Spring.....
660D	4477	" " " Screw.....
19848	-----	" " " Body.....
19849	4441	Shuttle Race complete, Nos. 660D, 19846 to 19848 and two 2049.....
134D	4465	Shuttle Race Screw.....
19850	4462	" " Frame with 11838.....
116D	4476	" " Clamping Screw.....
11838	4475	" " Position Pin.....
9121	4472	" " Slide (right) for 19858....

No.	Plate	Name
9122	4472	Shuttle Race Slide (left) for 19858.....
58255	4472	Spool Holder Bracket.....
58256	4472	Spool Holder Bracket complete, Nos. 11881 and 58255.....
1177D	4476	Spool Holder Bracket Screw.....
851E	4473	" " Tension Spool Pin with fixed cone.....
8018	4473	Spool Holder Tension Spool Pin Cone.....
1541E	4473	" " " " Nut.....
8019	4473	" " " " Spring...
11881	-----	Spool Holder Tension Spool Pin complete, Nos. 851E, 1541E, 8018 and 8019.....
11502	4473	Tension Bracket and Vibrating Presser Bar Cap with 11424.....
11501	-----	Tension Bracket and Vibrating Presser Bar Cap complete, Nos. 122E, 9525, 11502, 11506, 11936, 11937, 12042 and two 190J.....
159F	4473	Tension Bracket and Vibrating Presser Bar Cap Screw (left).....
145F	4473	Tension Bracket and Vibrating Presser Bar Cap Screw (right).....
5983	4473	Tension Friction Washer (felt).....
11423	4473	" " (steel).....
1560C	4473	" Regulating Thumb Nut.....
8905	4473	" " " Washer.....
607C	4473	" Screw Stud.....
58598	-----	" " 607C with 1560C.....
122E	4473	" " Clamping Screw.....
8791	4474	" Spring.....
11044	4474	" Wheel.....
12042	-----	Tension (wheel) complete, Nos. 8791, 8905, 11044, 11423, 58598 and two 5983.
11424	4474	Thread Eyelet for 11502.....
11950	4474	" " " 11503.....
11495	4468	" " (side of arm).....
190J	4468	" " " " Screw.....
2102	4474	" Retaining Disc.....
1560C	4473	" " Regulating Thumb Nut...
8905	4473	" " " " Washer.....
606E	4474	Thread Retaining Screw Stud.....
58597	-----	" " " 606E with 1560C.....
2103	4474	Thread Retaining Spring.....
11503	-----	Thread Retainer complete, Nos. 2103, 8905, 58597 and two 2102.....
11505	4461	Thread Take-up Cam with two 434C.....
8873	4475	" " " Pin.....
434C	4478	" " " Set Screw.....

ACCESSORIES

No.	Plate	Name
11361	4482	Bed Bracket (left) with wood screw 1 in. No. 16 (for machine on top of table)
11360	4482	Bed Bracket (right) with wood screw 1 in. No. 16 (for machine on top of table)
507E	4476	Bed Bracket Bolt with 1515E.....
1515E	4479	" " " Nut.....
41124	4480	Bridle Iron with four each 41125 and 51080E, for 5283, 5376, 29707, 29708 and 29711.....
51080E	7873	Bridle Iron Bolt with 51578E.....
51578E	7873	" " " Nut.....
41125	4483	" " " Washer.....
120344	4484	Oiler (copper plated) with 120345.....
120345	4484	" Spout, 4 1/2 in. long.....
11831	4484	Screw Driver (large).....
26026	4484	" " (small).....
126501	7871	Table Clamp.....
51092P	7873	" " Bolt with 1600E.....
126612	-----	" " " 51092P with 126079 and 126501 (for attaching tables to new steel work).....
1600E	7873	Table Clamp Bolt Nut.....
126079	7871	" " " " Lock Washer.....
8908	4484	Wrench for 1520.....
8909	4484	" " 692, 1513, 1524 and 50323...
8910	4484	" " 1508.....
8911	4484	" " 1503.....
23535	4484	" " 346, 1528 and 1547.....

BELT SHIFTER PARTS

FOR NO. 7-41 MACHINE

No.	Plate	Name
6439	-----	Chain, 36 in. to 45 in., with 56864 and 56865.....
Note: When ordering No. 6439, give length required.		
4879	7871	Chain Connecting Link.....
56864	7871	" Hook (large).....
56865	7871	" " (small).....
11446	7871	" Eyelet.....
9137	7872	" Pulley.....
10D	7872	" " Screw.....

BELT SHIFTER PARTS

No.	Plate	Name
11940	7878	Fork.....
434C	4478	" Set Screw.....
11941	7876	Frame with 8804 and two 434C.....
8804	7874	" Handle.....
19992	7874	Guide Rod.....
3012	7871	" " Pin.....
19993	7876	Pulley (loose).....
11459	7872	" " Collar with two 448C.....
448C	4469	" " " Set Screw.....
11451	7874	Slide Rod.....
2117	4475	" " Pin.....
11454	7874	" " Spring.....
11453	7872	" " Collar with two 448C....
448C	4469	" " " Set Screw.....
4881	7876	Treadle.....
4882	7871	" Shaft.....
4883	7872	" Spring.....
4884	7876	" Stand.....
4885	7876	Treadle complete, Nos. 4879, 4881 to 4884 and two wood screws 1 in. No. 16
19994	-----	Belt Shifter complete, Nos. 10D, 2117, 3012, 4885, 6439, 9137, 11446, 11451, 11453, 11454, 11459, 11940, 11941 and 19991 to 19993.....

BOBBIN WINDERS

BOBBIN WINDER

(SWINGING AUTOMATIC, LEFT HAND)

FOR NO. 7-31 MACHINE

No.	Plate	Name
41894	4485	Base with 449C.....
894E	4476	" Screw.....
60213	4483	Bobbin Position Pin.....
41896	4485	Frame.....
41441	4485	" Hinge Pin.....
449C	4478	" " " Set Screw.....
4784	4487	" Oil Pad (felt).....
41897	4485	" Spring.....
43270	4486	Friction Pulley with 43271, two 448C and ten 26070.....
43271	4486	Friction Pulley Ring (leather).....
26070	22796	" " " Rivet.....
448C	4469	" " " Set Screw.....

BOBBIN WINDER

No.	Plate	Name
60214	4486	Spindle.....
454C	4478	" Set Screw.....
60215	4486	" Shaft with 454C and 60213.....
60216	4486	Stop Latch.....
11107	4486	" " Hinge Pin.....
2269	4483	" " Pin.....
41899	4486	Tripping Arm with 176E.....
176E	4476	" " Clamping Screw.....
60217	4485	Bobbin Winder, Nos. 2269, 11107, 41441, 41894, 41896, 41897, 41899, 43270, 60214 to 60216 and two 4784.....
60218	4481	Bracket.....
50124D	4479	" Screw.....
9842	4475	" " Washer.....

THREAD UNWINDER PARTS

No.	Plate	Name
27555	7285	Spool Pin.....
27583	7285	" Rest.....
27556	-----	" " 27583 with 138B and two 27555
138B	4476	" " Set Screw.....
27557	7285	" Stand with 138B.....
2102	4474	Tension Disc.....
1560C	4473	" Regulating Thumb Nut.....
828C	4474	" Screw Stud.....
42418	-----	" " 828C with 1560C.....
2103	4474	" Spring.....
5769	4474	" Thread Eyelet.....
17547	4474	" " Guard.....
60608	7285	Thread Guard.....
27560	7285	" " Rod, 26 in. long.....
138B	4476	" " " Set Screw.....
330E	4478	" " " Set Screw.....
60609	-----	Thread Guard complete, Nos. 330E, 2103, 5769, 17547, 42418, 60608 and two 2102.
41823	7285	Thread Unwinder complete, for two large spools, Nos. 27556, 27557, 27560, 60609 and three wood screws 1 1/4 in. No. 12.....
60219	-----	Bobbin Winder (swinging automatic, left hand) complete, Nos. 9842, 41823, 50124D, 60217, 60218 and three 894E.

BOBBIN WINDER

(SWINGING AUTOMATIC, LEFT HAND)

FOR NO. 16901

FOR NO. 5841I, FOR NO. 7-33 MACHINE

THIS BOBBIN WINDER IS THE SAME AS NO. 60219,
WITH THE FOLLOWING EXCEPTIONS:

No.	Plate	Name
60274	22797	Bracket, in place of 60218.....
60278	-----	Bobbin Winder (swinging automatic, left hand) complete, Nos. 9842, 41823, 50124D, 60217, 60274 and three 894E.

BOBBIN WINDER

(SWINGING AUTOMATIC, LEFT HAND)

FOR NO. 16901

FOR NO. 58563, FOR NO. 7-33 MACHINE

THIS BOBBIN WINDER IS THE SAME AS NO. 60219,
WITH THE FOLLOWING EXCEPTIONS:

No.	Plate	Name
60227	22797	Bracket, in place of 60218.....
60279	-----	Bobbin Winder (swinging automatic, left hand) complete, Nos. 9842, 41823, 50124D, 60217, 60227 and three 894E.

BOBBIN WINDER

(SWINGING AUTOMATIC, LEFT HAND)

FOR NO. 16901, FOR NO. 7-41 MACHINE

THIS BOBBIN WINDER IS THE SAME AS NO. 60219,
WITH THE FOLLOWING EXCEPTIONS:

No.	Plate	Name
60264	22797	Bracket, in place of 60218.....
60278	-----	Bobbin Winder (swinging automatic, left hand) complete, Nos. 9842, 41823, 50124D, 60217, 60264 and three 894E.

DRIVING ATTACHMENT

FOR NO. 7-31 MACHINE

No.	Plate	Name
58649	22798	Balance Wheel with two 354C.....
58650	-----	" " 58649 with 58657, 122469, two 1402D and four 401J.....
25362	7978	Balance Wheel Ball, size 3/16 in.....
58651	22796	" " " Ring with eighteen 25362.....
58652	22796	Balance Wheel Ball Washer (left).....
22469	22796	" " " (right).....
1402D	7871	" " " " Screw.....
58657	22798	" " Friction Washer (paper)...
401J	4476	" " " " Screw.....
354C	4479	" " Set Screw.....
8984	4482	Brake Block (wood).....
58458	22796	" " Stud.....
1036C	22796	" " Set Screw.....
58653	22798	Friction Pulley, 7 in. diam., 1 1/2 in. face, with 448C and 58654.....
58654	22798	Friction Pulley Center Bearing.....
448C	4469	" " Set Screw.....
58459	22798	Lever with 1036C and 58458.....
58460	-----	" 58459 with 134D, 8984, 8991, 8992, 58462 and two 497E.....
59462	22797	Lever Bracket.....
497E	4479	" " Bolt with 1522E.....
1522E	4479	" " Nut.....
134D	4465	" Screw.....
8991	4482	" Washer.....
8992	4482	" Spring.....
14785	4482	" Hook (for machine on top of table).....
19863	4482	Lever Spring Hook (for machine flush with table).....
1520E	4479	Lever Spring Hook Nut.....
6055	4483	" " " Washer.....
9091	4480	Shaft Driving Pulley (sectional) 10 in. diam., 1 1/2 in. face, 1 3/16 in. bore, with two 597C.....
597C	4479	Shaft Driving Pulley Clamping Screw.....
126036	7878	Treadle.....
126037	-----	" 126036 with 2718, 50581R and 126038.....
126205	7876	Treadle Bracket (left).....
126207	7871	" " Hook.....

No.	Plate	Name
23258	7871	Treadle Bracket (left) Hook Friction Washer.....
126208	7871	Treadle Bracket (left) Hook Rivet.....
126206	-----	Treadle Bracket (left) complete, Nos. 23258, 126205, 126207, 126208 and two wood screws 1 in. No. 14.....
46681	7876	Treadle Bracket (right).....
60502	-----	" " 46681 with two wood screws 1 in. No. 14.....
126038	7876	Treadle Extension.....
50581R	7873	" " Screw.....
2718	4465	" " Washer.....
60858	7870	" Hanging Hook.....
27639	4462	" Pitman Rod.....
80223	22796	" " " Clamp with 361C.....
361C	22796	" " " Screw.....
60626	7875	Treadle Pitman complete, Nos. 80223 and 27639.....
126211	-----	Treadle complete, Nos. 60502, 126037 and 126206.....
126212	-----	Treadle and Pitman complete, Nos. 60626, 60858 and 126211.....
58655	-----	Driving Attachment complete, Nos. 1520E, 6055, 9091, 14785, 58460, 58650 to 58653 and 126212.....

DRIVING ATTACHMENT

FOR NO. 7-31 MACHINE

(OBSOLETE)

No.	Plate	Name
58247	4480	Balance Wheel with two 354C.....
58289	-----	" " 58247 with 11442 and four 401E.....
8873	4475	Balance Wheel Pin.....
354C	4479	" " Set Screw.....
8984	4482	Brake Block (wood).....
9D	4477	" " Screw.....
11440	4480	Friction Pulley, 7 in. diam., 1 1/2 in. face, with 448C and 11441.....
11441	4483	Friction Pulley Center Bearing.....
448C	4469	" " Set Screw.....
11442	4480	" " Washer (paper).....
401E	4476	" " " Screw.....
58248	4480	Lever.....

No.	Plate	Name
58286	-----	Lever 58248 with 9D, 134D, 8984, 8991, 8992, 19663 and two 497E.....
19663	4480	Lever Bracket.....
497E	4479	" " Bolt with 1522E.....
1522E	4479	" " " Nut.....
134D	4465	" Screw.....
8991	4482	" " Washer.....
8992	4482	" Spring.....
14785	4482	" " Hook (for machine on top of table).....
19863	4482	Lever Spring Hook (for machine flush with table).....
1520E	4479	Lever Spring Hook Nut.....
6055	4483	" " " Washer.....
11864	7879	Shaft Driving Pulley (sectional) 10 in. diam., 1 1/4 in. face, 1 3/16 in. bore, with two 597C.....
597C	4479	Shaft Driving Pulley Clamping Screw.....
126036	7878	Treadle.....
126205	7876	" Bracket (left).....
126206	-----	Treadle Bracket (left) complete, Nos. 23258, 126205, 126207, 126208 and two wood screws 1 in. No. 14.....
126207	7871	Treadle Bracket (left) Hook.....
23258	7871	" " " Friction Washer.....
126208	7871	Treadle Bracket (left) Hook Rivet.....
46681	7876	" " (right).....
60502	-----	" " " 46681 with two wood screws 1 in. No. 14.....
27637	4462	Treadle Pitman Rod (lower).....
150208	22796	" " " " Spring.....
6055	4483	" " " " Washer.....
27639	4462	" " " (upper).....
80223	22796	" " " Clamp with 361C.....
361C	22796	" " " Screw.....
27640	4462	Treadle Pitman complete, Nos. 2762, 6055, 27637, 27639, 80223 and 150208.....
2762	4483	Treadle Stop Collar with 362C.....
362C	4483	" " " Set Screw.....
126209	-----	Treadle complete, Nos. 60502, 126036 and 126206.....
126210	-----	Treadle and Pitman complete, Nos. 27640 and 126209.....
19862	-----	Driving Attachment complete, Nos. 1520E, 6055, 8873, 11440, 11864, 14785, 58286, 58289 and 126210.....

IRON WORK FOR No. 5283

(OBSOLETE)

No.	Plate	Name
27279	-----	Brace (table).....
27006	4480	" " 27279 with 499E and two each 12620 and wood screws 1 1/2 in. No. 14.....
499E	7288	Brace Bolt with 1522E.....
1522E	4479	" " Nut.....
12620	7288	" " " Washer.....
12620	7288	" " " Washer.....
27042	4480	Leg, 25 1/2 in. wide, with four each 1114E and 9281.....
1114E	7873	Leg Foot Screw.....
9281	7872	" " " Washer.....
27095	4480	Rail, 30 in., single flat, with two 492E, four each 12620, wood screws 1 in. No. 10 and eight wood screws 1 1/2 in. No. 14.....
492E	7288	Rail Bolt with 1522E.....
1522E	4479	" " Nut.....
12620	7288	" " " Washer.....
12620	7288	" " " Washer.....
41163	-----	Iron Work complete, two each Nos. 27006, 27042 and 27095.....

IRON WORK FOR No. 5376

(OBSOLETE)

No.	Plate	Name
27279	-----	Brace (table).....
27006	4480	" " 27279 with 499E and two each 12620 and wood screws 1 1/2 in. No. 14.....
499E	7288	Brace Bolt with 1522E.....
1522E	4479	" " Nut.....
12620	7288	" " " Washer.....
12620	7288	" " " Washer.....
27022	4481	Journal Box with 27029, 27030, 41157, 41158 and two 121E.....
*41157	-----	Journal Box Bottom.....
*41158	-----	" " Top.....

No.	Plate	Name
27025	4481	Journal Box Bracket, 6 in. drop, with 421E and 1507J.....
27028	4481	Journal Box Bracket Adjusting Slide.....
489E	7288	" " " Bolt with 1522E.....
1522E	4479	" " " " Nut.....
12620	7288	" " " " Washer.....
12620	7288	" " " " Washer.....
27029	4483	" " Oil Feeder (felt).....
27030	-----	" " " Reservoir.....
121E	4476	" " Screw.....
421E	4478	" " Set Screw.....
1507J	4479	" " " Nut.....
27042	4480	Leg, 25 1/2 in. wide, with four each 1114E and 9281.....
27043	-----	Leg complete, Nos. 489E, 27022, 27025, 27028, 27042 and two each 12620 and 41300.....
1114E	7873	Leg Foot Screw.....
9281	7872	" " " Washer.....
27061	4480	Pulley (sectional) 6 in. diam., 1 1/4 in. face, 1 3/16 in. bore, with two 597C.....
597C	4479	Pulley Clamping Screw.....
27095	4480	Rail, 30 in., single flat, with two 492E, four each 12620, wood screws 1 in. No. 10 and eight wood screws 1 1/2 in. No. 14.....
492E	7288	Rail Bolt with 1522E.....
1522E	4479	" " Nut.....
12620	7288	" " " Washer.....
12620	7288	" " " Washer.....
27104	7876	Safety Guard Bracket (left).....
27105	7876	" " " (right).....
41300	-----	Safety Guard Bracket complete, Nos. 492E, 27104, 27105 and two 12620.....
492E	7288	Safety Guard Bracket Bolt with 1522E....
1522E	4479	" " " " Nut.....
12620	7288	" " " " Washer....
12620	7288	" " " " Washer.....
27108	4481	Shaft Collar with 432C.....
432C	4478	" " Set Screw.....
-----	-----	Four feet two inches of 1 3/16 in. shafting.....
-----	-----	Thirteen feet of 1 in. flat belting....
41164	-----	Iron Work complete, Nos. 27061, two each 27006, 27043, 27095, 27108, four feet two inches of 1 3/16 in. shafting and thirteen feet of 1 in. flat belting.....

STAND
(ROCKING TREADLE)
FOR NO. 7-33 MACHINE

No.	Plate	Name
25004	7882	Band Wheel (two speed) 11 15/16 in. and 14 3/16 in. diam., with 9296.....
559E	7870	Band Wheel Stud.....
1503E	4478	" " " Nut.....
150D	7881	" " " Screw.....
25011	7881	" " " Washer.....
25114	7881	" " " Washer.....
25012	-----	Belt, size 3/8 in., length 80 1/2 in., with 25030.....
25030	7881	Belt Hook.....
25034	1860	Brace with two 46629.....
534E	7881	" Bolt with 1510E.....
1510E	7881	" " Nut.....
25061	1860	Leg (left).....
25062	1860	" (right).....
25073	7882	Pitman (wood).....
25089	7881	" Cotter Pin.....
9296	7881	" Stud.....
11743	7881	" Washer.....
25080	7882	Treadle with two each 164D, 25085 and 41544.....
297C	22796	Treadle Screw Center.....
46629	-----	" " " 297C with 1507R....
1507R	4479	" " " Nut.....
25085	-----	" Strap (leather).....
164D	4469	" " Screw.....
41544	4475	" " " Washer.....
25086	7870	Wrench for 1507 and 1510.....
25206	-----	Stand (iron work) complete, Nos. 150D, 559E, 1503E, 25004, 25011, 25034, 25061, 25062, 25073, 25080, 25114, two each 11743, 25089 and four 534E.....

From the library of: Diamond Needle Corp.

STAND
(ROTARY TREADLE)
FOR NO. 7-33 MACHINE

No.	Plate	Name
25087	4460	Band Wheel (two speed) 12 in. and 14 in. diam., with 25088.....
8873	4475	Band Wheel Pin.....
25090	4460	" " Shaft.....
25091	7870	" " Crank with 355C and 25088.....
8873	4475	" " " Pin.....
355C	7881	" " " Set Screw.....
25013	-----	Belt, size 3/8 in., length 86 1/2 in., with 25030.....
25030	7881	Belt Hook.....
25093	4459	Brace with 448C.....
534E	7881	" Bolt with 1510E.....
1510E	7881	" " Nut.....
25094	4459	Leg.....
25326	4460	" Stay Rod.....
1588C	7873	" " " Nut.....
25327	7881	" " " Packing.....
25328	-----	Leg Stay Rod complete, Nos. 25326 and two each 1588C and 25327.....
25095	4460	Pitman with four wood screws 1 1/8 in. No. 6 R.H.B.....
25089	7881	Pitman Cotter Pin.....
25088	7881	" Stud.....
11743	7881	" Washer.....
25096	7875	Treadle with four 129E.....
129E	7881	" Screw.....
25097	4460	" Shaft.....
25098	7870	" " Bushing.....
448C	4469	" " " Set Screw.....
25091	7870	" " Crank with 355C and 25088.....
8873	4475	" " " Pin.....
355C	7881	" " " Set Screw.....
25099	7881	" " Collar with 448C.....
448C	4469	" " " Set Screw.....
25086	7870	Wrench for 1510.....
25207	-----	Stand (iron work) complete, Nos. 25087, 25090, 25093, 25097 to 25099, 25328, two each 25094 to 25096, three 25091 and four each 534E, 8873, 11743 and 25089.

STEEL WORK
FOR NOS. 29707, 29708 AND 29712

No.	Plate	Name
126611	7880	Brace (table) with 1 1/4 in. No. 12 F.H.B. wood screw.....
126508	7880	Leg.....
51057N	7873	" Bolt with 1522E.....
1522E	4479	" " Nut.....
12620	7288	" " " Washer.....
126509	7871	" " " Socket Washer.....
126512	7880	" Cross Member, 25 1/4 in. long.....
51057N	7873	" " " Bolt with 1522E.....
1522E	4479	" " " Nut.....
12620	7288	" " " " Washer.....
126509	7871	" " " " Socket Washer.....
51038E	7873	" Foot Screw.....
9842	4475	" " " Washer.....
126514	-----	Leg with Rail complete, Nos. 126512, 126516, two 126508 and four each 9842, 12620, 51038E, 51057N and 126509.
126516	7880	Rail, 32 3/8 in. long.....
126616	-----	Steel Work complete, two each Nos. 126514 and 126611.....

STEEL WORK

FOR NO. 29711, FOR S. A. NO. 5410 MOTOR

No.	Plate	Name
126611	7880	Brace (table) with 1 1/4 in. No. 12 F.H.B. wood screw.....
27022	4481	Journal Box with 27029, 27030, 41157, 41158 and two 121E.....
*41157	-----	Journal Box Bottom.....
*41158	-----	" " Top.....
27121	7878	" " Bracket, 8 in. drop, with 421E and 1507J.....
839R	7873	Journal Box Bracket Bolt with 1522E.....
1522E	4479	" " " " Nut.....
12620	7288	" " " " Washer.....
126504	7876	" " Hanger Bracket.....
126957	-----	" " " " 126504 with 839R, 12620, 51057R and 126509.....

STEEL WORK

No.	Plate	Name
51057R	7873	Journal Box Hanger Bracket Bolt with 1522E.....
1522E	4479	Journal Box Hanger Bracket Bolt Nut.....
12620	7288	" " " " " Washer.....
126509	7871	Journal Box Hanger Bracket Bolt Socket Washer.....
126505	-----	Journal Box Hanger Bracket complete, Nos. 27022, 27121 and 126957.....
27029	4483	Journal Box Oil Feeder (felt).....
27030	-----	" " " Reservoir.....
121E	4476	" " Screw.....
421E	4478	" " Set Screw.....
1507J	4479	" " " " Nut.....
126508	7880	Leg.....
51057N	7873	" Bolt with 1522E.....
1522E	4479	" Nut.....
12620	7288	" " Washer.....
126509	7871	" " Socket Washer.....
126512	7880	" Cross Member, 25 1/4 in. long.....
51057N	7873	" " Bolt with 1522E.....
1522E	4479	" " Nut.....
12620	7288	" " Washer.....
126509	7871	" " Socket Washer.....
51038E	7873	" Foot Screw.....
9842	4475	" " Washer.....
126514	-----	Leg with Rail complete, Nos. 126512, 126516, two 126508 and four each 9842, 12620, 51038E, 51057N and 126509.
27061	4480	Pulley (sectional) 6 in. diam., 1 1/4 in. face, 1 3/16 in. bore, with two 597C.....
597C	4479	Pulley Clamping Screw.....
126516	7880	Rail, 32 3/8 in. long.....
27108	4481	Shaft Collar with 432C.....
432C	4478	" " Set Screw.....
-----	-----	Four feet two inches of 1 3/16 in. shafting.....
-----	-----	Thirteen feet of 1 in. flat belting.....
126620	-----	Steel Work complete, Nos. 27061, two each 27108, 126505, 126514, 126611, four feet two inches of 1 3/16 in. shafting and thirteen feet of 1 in. flat belting.....

STEEL WORK

FOR NO. 29711 WITH S. D. A.

No.	Plate	Name
126611	7880	Brace (table) with 1 1/4 in. No. 12 F.H.B. wood screw.....
27015	7878	Floor Stand or Hanger Foot, 5 in., with six wood screws 1 1/2 in. No. 16....
27018	-----	Floor Stand complete, Nos. 492E, 12620, 27015, 27022, 27026 and 27028.....
27022	4481	Journal Box with 27029, 27030, 41157, 41158 and two 121E.....
*41157	-----	Journal Box Bottom.....
*41158	-----	" " Top.....
27026	7878	" " Bracket, 6 in. high, with 421E and 1507J, for 27018.....
27121	7878	Journal Box Bracket, 8 in. drop, with 421E and 1507J, for 126505.....
27028	4481	Journal Box Bracket Adjusting Slide....
492E	7288	" " Bolt with 1522E, for 27018.....
839R	7873	Journal Box Bracket Bolt with 1522E, for 126505.....
1522E	4479	Journal Box Bracket Bolt Nut.....
12620	7288	" " " " Washer....
126504	7876	" " Hanger Bracket.....
126957	-----	" " " " 126504 with 839R, 12620, 51057R and 126509 ...
51057R	7873	Journal Box Hanger Bracket Bolt with 1522E.....
1522E	4479	Journal Box Hanger Bracket Bolt Nut....
12620	7288	" " " " " Washer.....
126509	7871	Journal Box Hanger Bracket Bolt Socket Washer.....
126505	-----	Journal Box Hanger Bracket complete, Nos. 27022, 27121 and 126957.....
27029	4483	Journal Box Oil Feeder (felt).....
27030	-----	" " " Reservoir.....
121E	4476	" " Screw.....
421E	4478	" " Set Screw.....
1507J	4479	" " " " Nut.....
126508	7880	Leg.....
51057N	7873	" Bolt with 1522E.....
1522E	4479	" Nut.....
12620	7288	" " Washer.....
126509	7871	" " Socket Washer.....

STEEL WORK

No.	Plate	Name
126512	7880	Leg Cross Member, 25 1/4 in. long.....
51057N	7873	" " " Bolt with 1522E.....
1522E	4479	" " " " Nut.....
12620	7288	" " " " Washer.....
126509	7871	" " " " Socket Washer
51038E	7873	" Foot Screw.....
9842	4475	" " " Washer.....
126514	-----	Leg with Rail complete, Nos. 126512, 126516, two 126508 and four each 9842, 12620, 51038E, 51057N and 126509.
126516	7880	Rail, 32 3/8 in. long.....
27108	4481	Shaft Collar with 432C.....
432C	4478	" " Set Screw.....
-----	-----	Driving Pulley, 10 in. diam., 3 in. face, 1 3/16 in. bore.....
-----	-----	Five feet of 1 3/16 in. shafting.....
-----	-----	Nine feet of 1 in. flat belting.....
126619	-----	Steel Work complete, Nos. 27018, pulley (solid) 10 in. diam., 3 in. face, 1 3/16 in. bore, two each 27108, 126505, 126514, 126611, five feet of 1 3/16 in. shafting and nine feet of 1 in. flat belting.....

STEEL WORK

FOR NO. 29710

No.	Plate	Name
41161	-----	Belt, size 5/16 in., length 55 3/4 in., with 25029.....
25029	7871	Belt Hook.....
126611	7880	Brace (table) with 1 1/4 in. No. 12 F.H.B. wood screw.....
27015	7878	Floor Stand or Hanger Foot, 5 in., with six wood screws 1 1/2 in. No. 16....
27016	-----	Floor Stand complete, Nos. 492E, 12620, 27015, 27022, 27026 and 27028.....
27022	4481	Journal Box with 27029, 27030, 41157, 41158 and two 121E.....
*41157	-----	Journal Box Bottom.....
*41158	-----	" " Top.....
27026	7878	" " Bracket, 6 in. high, with 421E and 1507J, for 27018.....
27121	7878	Journal Box Bracket, 8 in. drop, with 421E and 1507J, for 126505.....
27028	4481	Journal Box Bracket Adjusting Slide....

STEEL WORK

No.	Plate	Name
492E	7288	Journal Box Bracket Bolt with 1522E, for 27018.....
839R	7873	Journal Box Bracket Bolt with 1522E, for 126505.....
1522E	4479	Journal Box Bracket Bolt Nut.....
12620	7288	" " " " Washer.....
126504	7876	" " Hanger Bracket.....
126957	-----	" " " " 126504 with 839R, 12620, 51057R and 126509.....
51057R	7873	Journal Box Hanger Bracket Bolt with 1522E.....
1522E	4479	Journal Box Hanger Bracket Bolt Nut.....
12620	7288	" " " " " " Washer.....
126509	7871	Journal Box Hanger Bracket Bolt Socket Washer.....
126505	-----	Journal Box Hanger Bracket complete, Nos. 27022, 27121 and 126957.....
27029	4483	Journal Box Oil Feeder (felt).....
27030	-----	" " Reservoir.....
121E	4476	" " Screw.....
421E	4478	" " Set Screw.....
1507J	4479	" " " " Nut.....
126508	7880	Leg.....
51057N	7873	" Bolt with 1522E.....
1522E	4479	" " Nut.....
12620	7288	" " " Washer.....
126509	7871	" " Socket Washer.....
126512	7880	" Cross Member, 25 1/4 in. long.....
51057N	7873	" " " Bolt with 1522E.....
1522E	4479	" " " " Nut.....
12620	7288	" " " " Washer.....
126509	7871	" " " " " Socket Washer
51038E	7873	" Foot Screw.....
9842	4475	" " " Washer.....
126514	-----	Leg with Rail complete, Nos. 126512, 126516, two 126508 and four each 9842, 12620, 51038E, 51057N and 126509.
126516	7880	Rail, 32 3/8 in. long.....
27108	4481	Shaft Collar with 432C.....
432C	4478	" " Set Screw.....
-----	-----	Driving Pulley (solid) 10 in. diam., 2 in. face, 1 3/16 in. bore.....
-----	-----	Five feet of 1 3/16 in. shafting.....
-----	-----	Four feet nine inches of 1 in. flat belting.....

UNDER DRIVER PARTS

No.	Plate	Name
126583	7877	Base with two 50288C.....
126572	7980	Belt Guard.....
50058D	7978	" " Screw.....
126584	7980	" Tightener Screw.....
55767	7978	" " " Hinge Stud.....
50288C	7978	" " " " " Set Screw.....
1796E	7978	Belt Tightener Screw Nut.....
126585	7979	" " " " Washer.....
126573	7978	Brake (thermo)id.....
126791	22797	" Lever with 50058R, 51067C and two 60823.....
127000	22796	Brake Lever Separating Washer.....
51067C	7978	" " Set Screw.....
126575	7980	" " Spring.....
126169	7877	Driving Pulley (right hand) 6 3/4 in. diam., with 60911, 60935, 126202 and two 126895.....
60911	7877	Driving Pulley Friction Ring (leather)..
60935	7978	" " " " Stop Pin...
*126756	7877	" " Shaft (hollow).....
126576	-----	Driving Pulley Shaft (hollow) 126756 with 204107, 204108 and eleven 25303
126577	-----	Driving Pulley Shaft complete, Nos. 126173, 126175, 126576, 126578 and 126757.....
25303	7978	Driving Pulley Shaft Ball, size 1/4 in..
204107	7979	" " " " Cup.....
204108	7979	" " " " " Cap.....
126173	7978	" " " " Oiling Leather.....
126757	-----	" " " " " Clip
126175	7978	" " " " " Plug (leather).....
126578	7980	Driving Pulley Shaft Oil Wick.....
50959C	7978	" " " Set Screw.....
204113	7978	" " " Thimble.....
126895	22796	" " Spring.....
126201	7979	" " Retaining Washer..
126202	-----	Driving Pulley Spring Retaining Washer complete, Nos. 126201 and 126203....
126203	7978	Driving Pulley Spring Retaining Washer Pin.....
126586	7877	Frame with 50959C.....
40063	7980	" Hinge Pin.....

No.	Plate	Name
50288C	7978	Frame Hinge Pin Set Screw.....
126179	7877	Friction Pulley (right hand) with 227553 and four 50512E.....
25362	7978	Friction Pulley Ball, size 3/16 in.....
204100	7979	" " " Bearing Cap.....
204101	7979	" " " Cap.....
204102	7979	" " " Retaining Spring..
227553	-----	Friction Pulley Ball complete, Nos. 204100 to 204102 and thirteen 25362.
126792	22797	Lever (compression) and Dress Guard with 200524C, 204117 and two 202845.....
200524C	7978	Lever (compression) and Dress Guard Set Screw.....
204117	7979	Lever Compression Plate.....
202845	7978	" " " Rivet.....
126580	7874	" Shaft.....
123183	7978	" " Cotter Pin.....
423C	22796	" Stop Screw.....
60823	-----	" " " 423C with 1520R.....
1520R	4479	" " " Nut.....
126587	-----	Pulley (flat) 3 in. diam.....
126588	7877	" " 4 in. diam.....
126589	-----	" " 5 in. diam.....
Note: No.126588 is sent with this transmitter unless another Pulley is specified on order.		
50512E	7978	Pulley Screw.....
11864	7879	Shaft Driving Pulley (sectional) 10 in. diam., 1 1/4 in. face, 1 3/16 in. bore, with two 597C.....
597C	4479	Shaft Driving Pulley Clamping Screw....
234377	7878	Treadle with 201480C and 350231C.....
234381	7876	" Crank with 201480C and 350231C..
350231C	-----	" " Position Screw.....
201480C	7873	" Set Screw.....
27639	4462	" Pitman Rod.....
80223	22796	" " " Clamp with 361C.....
361C	22796	" " " " Screw.....
60626	7875	Treadle Pitman complete, Nos. 80223 and two 27639.....
350231C	-----	Treadle Position Screw.....
201480C	7873	" Set Screw.....
126734	7874	" Support Bracket with two 362C...
126735	7880	" " " Rod, 25 7/8 in. long.....
362C	4483	Treadle Support Bracket Set Screw.....
126736	7880	" " Rod, 45 3/16 in. long...
1588R	7873	" " Nut.....
25446	7872	" " " Washer.....
126737	7880	" " " Tube, 43 1/4 in. long.....

UNDER DRIVER PARTS

No.	Plate	Name
126739	-----	Treadle and Pitman complete, Nos. 60626, 234377 and 234381.....
126590	-----	Transmitter (belt tightener) complete, Nos. 40063, 55767, 123183, 126169, 126179, 126572, 126573, 126575, 126577, 126580, 126583, 126584, 126586, 126588, 126791, 126792, 127000, 204113, two each 1796E, 126585 and three wood screws 1 3/4 in. No. 16.....
126740	-----	Under Driver (belt tightener) lever pressure (right hand) one speed, flat pulley, complete, Nos. 11864, 126590 and 126739.....
126616	-----	Steel Work complete, Nos. 2701E, 41161, 126736, 126737, 126740, pulley (solid) 10 in. diam., 2 in. face, 1 3/16 in. bore, two each 1588R, 25446, 27108, 126505, 126514, 126611, 126734, 126735, five feet of 1 3/16 in. shafting and four feet nine inches of 1 in. flat belting.....

TABLE BELT GUIDE

FOR NO. 297II, FOR NO. 7-31 MACHINE

No.	Plate	Name
58263	7876	Bracket with 448C.....
58264	7876	Pulley.....
58265	7874	" Shaft with 58266 and 58267.....
58266	7872	" " Oil Hole Plug.....
58267	-----	" " Packing (wick).....
448C	4469	" " Set Screw.....
58268	-----	Table Belt Guide complete, Nos. 58264, 58265, two 58263 and eight wood screws 1 1/2 in. No. 14 R.H.E.....

THREAD UNWINDER

FOR TWO LARGE SPOOLS OF THREAD

FOR NO. 520I, FOR NO. 25207

No.	Plate	Name
60636	7878	Holder with 138B.....
27555	7285	Spool Pin.....
27583	7285	" Rest.....

THREAD UNWINDER

No.	Plate	Name
27556	-----	Spool Rest 27583 with 138B and two 27555
138B	4476	" " Set Screw.....
2102	4474	Tension Disc.....
1560C	4473	" Regulating Thumb Nut.....
828C	4474	" Screw Stud.....
42418	-----	" " " 828C with 1560C.....
2103	4474	" Spring.....
5769	4474	" Thread Eyelet.....
17547	4474	" " Guard.....
60608	7285	Thread Guard.....
27693	7882	" " Rod, 37 in. long.....
138B	4476	" " " Set Screw.....
330E	4478	" " " Set Screw.....
60609	-----	Thread Guard complete, Nos. 330E, 2103, 5769, 17547, 42418, 60608 and two 2102.
60637	-----	Thread Unwinder complete, Nos. 27556, 27693, 60609, 60636 and two wood screws 1 1/4 in. No. 12.....

OBSOLETE PARTS

No.	Plate	Name
*19831	-----	Arm for 11494, 11497 and 11879.....
19748	4461	" Shaft for 7-31 Machine, use 58587..
58587	22798	" " for 7-31 Machine.....
58334	7875	" " for 7-31 Machine, use 58588..
58588	-----	" " for 7-31 Machine, obsolete, superseded by 58648, not interchangeable.....
8708	4487	Arm Spool Pin.....
11241	4487	" " " Washer (cloth).....
11438	-----	Balance Wheel with two 354C, for 7-31 Machine.....
58247	4480	Balance Wheel with two 354C, for 7-31 Machine.....
58249	7879	Balance Wheel (two speed) with two 354C, for 7-33 Machine, superseded by 58563, not interchangeable.....
58335	7879	Balance Wheel with two 354C, for 58336, obsolete, superseded by 58649, not interchangeable.....
58336	-----	Balance Wheel 58335 with 11442, 122469, two 1402D and four 401J, for 7-31 Machine, obsolete, superseded by 58650, not interchangeable.....
122303	-----	Balance Wheel Ball Ring for 122304.....

From the library of: Diamond Needle Corp

OBSOLETE PARTS

No.	Plate	Name
122304	7874	Balance Wheel Ball Ring 122303 with eighteen 25362, for 7-31 Machine, obsolete, superseded by 58651, not interchangeable.....
122306	7874	Balance Wheel Ball Washer (left) for 7-31 Machine, obsolete, superseded by 58652, not interchangeable.....
122307	7874	Balance Wheel Ball Washer (right) obsolete, superseded by 122469, not interchangeable.....
11442	4480	Balance Wheel Friction Washer (paper) for 58336, obsolete, superseded by 58657, not interchangeable.....
8873	4475	Balance Wheel Pin for 7-31 Machine.....
15405	7871	Bobbin Winder Friction Pulley Ring Rivet, use 26070.....
19833	-----	Cloth Plate, use 58222.....
58335	7879	Driving Attachment Balance Wheel with two 354C, for 58336, obsolete, superseded by 58649, not interchangeable.....
58336	-----	Driving Attachment Balance Wheel 58335 with 11442, 122469, two 1402D and four 401J, for 58380, obsolete, superseded by 58650, not interchangeable.....
122303	-----	Driving Attachment Balance Wheel Ball Ring for 122304.....
122304	7874	Driving Attachment Balance Wheel Ball Ring 122303 with eighteen 25362, for 58380, obsolete, superseded by 58651, not interchangeable.....
122306	7874	Driving Attachment Balance Wheel Ball Washer (left) for 58380, obsolete, superseded by 58652, not interchangeable.....
122307	7874	Driving Attachment Balance Wheel Ball Washer (right) obsolete, superseded by 122469, not interchangeable.....
11442	4480	Driving Attachment Balance Wheel Friction Washer (paper) for 58336, obsolete, superseded by 58657, not interchangeable.....
9D	4477	Driving Attachment Brake Block Screw for 58286.....
11440	4480	Driving Attachment Friction Pulley 7 in. diam., 1 1/2 in. face with 448C and 11441, for 19862 and 58380, obsolete, superseded by 58653, not interchangeable.....

OBSOLETE PARTS

No.	Plate	Name
11441	4483	Driving Attachment Friction Pulley Center Bearing for 11440, obsolete, superseded by 58654, not interchangeable.....
58248	4480	Driving Attachment Lever for 58286, use 58459.....
58286	-----	Driving Attachment Lever 58248 with 9D, 134D, 8984, 8991, 8992, 19663 and two 497E, for 58380, use 58460.....
19663	4480	Driving Attachment Lever Bracket for 58286, use 58462.....
27636	4481	Driving Attachment Treadle for 27642....
9082	4483	" " " Bearing Cotter Pin for 27642.....
2878	4481	Driving Attachment Treadle Stand for 27642.....
27642	-----	Driving Attachment Treadle complete for 27643, Nos. 2878, 9082, 27636 and four wood screws 1 in. No. 16.....
9079	4483	Driving Attachment Treadle Pitman Rod Clamp with 354C, use 80223.....
354C	4479	Driving Attachment Treadle Pitman Rod Clamp Screw for 9079.....
27638	4462	Driving Attachment Treadle Pitman Rod (lower) Spring, use 150208.....
27643	-----	Driving Attachment Treadle and Pitman complete for 19862, Nos. 27640 and 27642, use 126210.....
58380	-----	Driving Attachment complete for 7-31 Machine, Nos. 1520E, 6055, 9091, 11440, 14785, 58286, 58336, 122304, 122306 and 126210, obsolete, superseded by 58655, not interchangeable.....
304C	4478	Feed Bar Screw Center.....
9093	4462	" Lifting Rock Shaft for 19836.....
19836	-----	Feed Lifting Rock Shaft complete, Nos. 9093 and 19837, use 58288.....
254D	4477	Feed Regulator Thumb Screw.....
19838	4461	" Rock Shaft.....
19839	-----	Feed Rock Shaft complete, Nos. 11379 and 19838, use 58244.....
11379	4487	Feed Rock Shaft Crank with 453C, for 19839.....
2117	4475	Feed Rock Shaft Crank Pin.....
453C	4466	" " " " Set Screw for 11379
497R	4479	Journal Box Hanger Bracket Bolt with 1522E, use 51057R.....
11475	4482	Lifting Presser Bar.....
11476	850	" " " Bell Crank, obsolete, superseded by 58617, not interchangeable.....

From the library of: Diamond Needle Corp

No.	Plate	Name
166D	4476	Lifting Presser Bar Bell Crank Hinge Cap Screw.....
1851	4465	Lifting Presser Bar Bell Crank Lifting Roller with 610D.....
610D	4465	Lifting Presser Bar Bell Crank Lifting Roller Screw for 1851.....
11478	850	Lifting Presser Bar Bracket with two 145E, use 58643.....
8765	4487	Lifting Presser Bar Lifting Hinge Stud Washer, use 43267.....
11480	850	Lifting Presser Bar Rock Shaft Adjusting Arm with 453C, use 58578.....
190D	4468	Lifting Presser Bar Rock Shaft Adjusting Arm Set Screw.....
11494	850	Lifting Presser Bar Spring Bracket with 12232.....
138E	4476	Lifting Presser Bar Spring Bracket Screw
12232	4487	" " " " Guide Pin for 11494.....
609D	4478	Lifting Presser Bar Spring Regulating Thumb Screw.....
19840	4487	Lifting Presser Foot with 211F, for 19834.....
19841	4487	Lifting Presser Foot with 211F, for 19835.....
2049	4475	Lifting Presser Foot Pin.....
211F	4487	" " " Set Screw for 19840 and 19841.....
11497	-----	O11 Cup for 11921.....
11919	4468	" " Thread Eyelet for 11921.....
11921	4481	O11 Cup complete, Nos. 2205, 8482, 9084, 11497, 11917, 11918, two 8953 and three 207F.....
19768	4461	Oscillating Rock Shaft, obsolete, superseded by 58550, not interchangeable.
19790	-----	Oscillating Rock Shaft complete, Nos. 654C, 9115, 11165, 19768 and two 1503J, obsolete, superseded by 58558, not interchangeable.....
9115	4461	Oscillating Rock Shaft Hinge Pin, obsolete, superseded by 58552, not interchangeable.....
654C	4478	Oscillating Rock Shaft Hinge Pin Screw Bearing for 19790.....
43273	7871	Shuttle Bobbin Center Pin for 43284.....
8776	3564	" Cylinder for 43246.....
43246	-----	" " 8776 with 1323F and 8780, for 19844 and 19976.....
43284	7870	Shuttle Cylinder with 43273, for 43288, use 58207.....

No.	Plate	Name
43288	-----	Shuttle Cylinder 43284 with 1323F and 58209, use 58271.....
43235	4471	Shuttle Cylinder Latch, use 58644.....
8778	3564	" " " Spring for 19989
19869	4471	" " " " for 58272, use 58666.....
330D	3564	Shuttle Cylinder Latch Spring Screw for 19989.....
19843	3564	Shuttle Frame for 19989.....
19989	-----	" " 19843 with 330D and 8778, for 19844.....
19975	4488	Shuttle Frame for 58206.....
58206	-----	" " 19975 with 19869, 43235 and 43236, for 19976.....
58208	4470	Shuttle Frame for 58272, obsolete, superseded by 58667, not interchangeable.....
58272	-----	Shuttle Frame 58208 with 19869, 43235 and 43236, obsolete, use 58666.....
8780	3564	Shuttle Tension Spring for 43246.....
19844	3563	Shuttle (cylinder) 4 in. diam. complete, Nos. 8777, 16901, 19989 and 43246, use 19976.....
19976	-----	Shuttle (cylinder) 4 in. diam. complete, Nos. 8777, 16901, 43246 and 58206, use 58210.....
58210	4471	Shuttle (cylinder) 4 in. diam. complete, Nos. 8777, 16901, 58271 and 58272, use 58323.....
58323	7870	Shuttle (cylinder) 4 in. diam. complete, Nos. 8777, 16901, 43288 and 58272, use 58669.....
11879	-----	Spool Holder Bracket for 11880.....
11880	-----	Spool Holder Bracket complete, Nos. 11879 and 11881.....
8879	4483	Tension Friction Washer.....
19852	4482	Thread Take-up Lever with 1948 and 1995.
58307	-----	" " " for 58308.....
58308	4472	" " " 58307 with 1948 and 1995, use 58332.....
567D	4477	Thread Take-up Lever Hinge Screw.....
1948	4475	" " " Thread Guiding Roller and Screw Stud for 19852 and 58308..
296C	7881	Treadle Screw Center, use 297C.....
46661	-----	" " " 296C with 1507R, for 25034, use 46629.....
126574	7877	Under Driver Brake Lever with 51067C, obsolete, superseded by 126791, not interchangeable.....
27414	7978	Under Driver Driving Pulley Spring, for 126169, obsolete, superseded by 126895, not interchangeable.....

No.	Plate	Name
227970	7877	Under Driving Lever (compression) and Dress Guard with 204117 and two each 200524C and 202845, for 126590, obsolete, superseded by 126792, not interchangeable.....
9079	4483	Under Driver Treadle Pitman Rod Clamp with 354C, for 60626, use 80223.....
354C	4479	Under Driver Treadle Pitman Rod Clamp Screw for 9079, use 361C.....
19859	4482	Vibrating Presser Bar for 19703.....
11510	850	" " " Hinge Bracket with 145E, obsolete, superseded by 58620, not interchangeable.....
19703	4487	Vibrating Presser Foot for 19835, obsolete, superseded by 58262, not interchangeable.....

SINGER Needles should be used in SINGER Machines. These Needles and their Containers are marked with the Company's Trade Mark "SIMANCO.***" 1

Needles in Containers marked "FOR SINGER MACHINES" are NOT **SINGER** made needles. 2

NUMERICAL LIST OF PARTS

No.	Plate	Name
9D	4477	Driving Attachment Brake Block Screw for 58286, obsolete.....
10D	7872	Belt Shifter Chain Pulley Screw for 19994.....
16D	4477	Lifting Presser Bar Lifter Hinge Screw..
65D	4477	Arm Side Cover Hinge Screw.....
116D	4476	Shuttle Race Frame Clamping Screw.....
121E	4476	Journal Box Screw for 27022.....
122E	4473	Tension Screw Stud Clamping Screw for 11501.....
123E	4476	Lifting Presser Bar Rock Shaft Bracket Screw.....
129E	7881	Treadle Screw for 25096.....
134D	4465	Driving Attachment Lever Screw for 58286 and 58460.....
134D	4465	Feed Lifting Rock Shaft Wearing Block Screw for 9225.....
134D	4465	Oil Cup Screw.....
134D	4465	Shuttle Race Screw.....
138E	4476	Lifting Presser Bar Spring Bracket Screw, obsolete.....
138E	4476	Thread Unwinder Spool Rest Set Screw for 27556.....
138E	4476	Thread Unwinder Thread Guard Rod Set Screw for 27557 and 60636.....
141E	4476	Lifting Presser Bar Rock Shaft Eccentric Strap Adjusting Screw for 11486....
145E	4473	Lifting Presser Bar Bracket Clamping Screw for 11478 and 58643.....
145F	4473	Tension Bracket and Vibrating Presser Bar Cap Screw (right).....
145E	4473	Vibrating Presser Bar Hinge Bracket Adjusting Screw for 11510 and 58620...
150D	7881	Band Wheel Stud Screw for 25206.....
159F	4473	Tension Bracket and Vibrating Presser Bar Cap Screw (left).....
164E	4469	Oscillating Shaft Crank Slide Block Cap Screw for 19773.....
164D	4469	Treadle Strap Screw for 25080.....
164D	4469	Vibrating Presser Bar Hinge Cap Screw...
166D	4476	Feed Dog Screw.....
166D	4476	Lifting Presser Bar Bell Crank Hinge Cap Screw, obsolete.....
166D	4476	Lifting Presser Bar Lifting Link Cap Screw.....
176E	4476	Bobbin Winder Tripping Arm Clamping Screw for 41899.....

From the library of: Diamond Needle Corp

No.	Plate	Name
190D	4468	Lifting Presser Bar Rock Shaft Adjusting Arm Set Screw, obsolete.....
190J	4468	Thread Eyelet (side of arm) Screw.....
190J	4468	" Take-up Spring Regulator Plate Adjusting Screw for 11501.....
190J	4468	Vibrating Presser Bar Spring Adjusting Staple Screw.....
207F	4468	Oil Cup Cover Latch Spring Screw for 11921 and 58254.....
207F	4468	Oil or Wax Stripper Washer Screw for 11921 and 58254.....
211F	4487	Lifting Presser Foot Set Screw for 19840 and 19841, obsolete.....
223D	4475	Vibrating Presser Bar Spring Screw.....
231F	4476	Throat Plate Needle Plate Screw for 19858.....
233D	4475	Vibrating Presser Bar Cushion Screw.....
254D	4477	Feed Regulator Thumb Screw, obsolete....
258E	4477	Lifting Presser Bar Screw Bushing.....
258E	4477	Needle Bar Screw Bushing.....
294C	4478	Feed Lifting Rock Shaft Screw Center (right).....
294C	4478	Feed Rock Shaft Screw Center (right)....
296C	7881	Treadle Screw Center for 46661, obsolete, use 297C.....
297C	22796	Treadle Screw Center for 46629.....
304C	4478	Feed Bar Screw Center, obsolete.....
330D	3564	Shuttle Cylinder Latch Spring Screw for 19989, obsolete.....
330E	4478	Thread Unwinder Thread Guard Set Screw for 60609.....
346E	4465	Feed Rock Shaft Crank Clamping Screw for 58235.....
354C	4479	Balance Wheel Set Screw for 11438, 19991, 58247, 58249, 58335, 58411 and 58649.....
354C	4479	Driving Attachment Balance Wheel Set Screw for 58247, 58335 and 58649....
354C	4479	Driving Attachment Treadle Pitman Rod Clamp Screw for 9079, obsolete.....
354C	4479	Under Driver Treadle Pitman Rod Clamp Screw for 9079, obsolete, use 361C..
355C	7881	Band Wheel Shaft Crank Set Screw for 25091.....
355C	7881	Treadle Shaft Crank Set Screw for 25091.
361C	22796	Driving Attachment Treadle Pitman Rod Clamp Screw for 80223.....
362C	4483	Treadle Shaft Crank Support Bracket Set Screw for 126734.....
362C	4483	Driving Attachment Treadle Stop Collar Set Screw for 2762, obsolete.....

No.	Plate	Name
381D	4476	Throat Plate Screw.....
389F	4476	Cloth Plate Screw.....
389F	4476	Throat Plate Needle Hole Strip Screw for 19855.....
401J	4476	Balance Wheel Friction Washer Screw for 58336 and 58650.....
401J	4476	Driving Attachment Balance Wheel Friction Washer Screw for 58336 and 58650.....
401E	4476	Driving Attachment Friction Pulley Washer Screw for 58289, obsolete.....
421E	4478	Journal Box Set Screw for 27025, 27026 and 27121.....
423C	22796	Under Driver Lever Stop Screw for 60823.
432C	4478	Shaft Collar Set Screw for 27108.....
434C	4478	Belt Shifter Fork Set Screw for 11941...
434C	4478	Thread Take-up Cam Set Screw for 11505..
437C	4478	Arm Shaft Bushing Set Screw.....
445C	4478	Feed Cam Set Screw for 11367.....
445F	4478	Needle Bar Connecting Stud Set Screw for 11383.....
445C	4478	Oscillating Shaft Crank Set Screw for 19770.....
445C	4478	Shuttle Driver Set Screw for 19845.....
448C	4469	Belt Shifter Pulley (loose) Collar Set Screw for 11459.....
448C	4469	Belt Shifter Slide Rod Spring Collar Set Screw for 11453.....
448C	4469	Bobbin Winder Friction Pulley Set Screw for 43270.....
448C	4469	Driving Attachment Friction Pulley Set Screw for 11440 and 58653.....
448C	4469	Oscillating Shaft Collar Set Screw for 9152.....
448C	4469	Table Belt Guide Pulley Shaft Set Screw for 58263.....
448C	4469	Treadle Shaft Bushing Set Screw for 25093.....
448C	4469	Treadle Shaft Collar Set Screw for 25099
449C	4478	Bobbin Winder Frame Hinge Pin Set Screw for 41894.....
453C	4466	Feed Rock Shaft Crank Set Screw for 11379, obsolete.....
453C	4466	Lifting Presser Bar Rock Shaft Adjusting Arm Set Screw for 11480 and 58578...
453C	4466	Lifting Presser Bar Rock Shaft Crank Set Screw for 11484.....
454C	4478	Bobbin Winder Spindle Set Screw for 60215.....
489E	7288	Journal Box Bracket Bolt with 1522E, for 27043, obsolete.....

NUMERICAL LIST OF PARTS

No.	Plate	Name
492E	7288	Journal Box Bracket Bolt with 1522E, for 27018.....
492E	7288	Rail Bolt with 1522E, for 27095, obsolete.....
492E	7288	Safety Guard Bracket Bolt with 1522E, for 41300, obsolete.....
497E	4479	Driving Attachment Lever Bracket Bolt with 1522E, for 58286 and 59460.....
497R	4479	Journal Box Hanger Bracket Bolt with 1522E, obsolete, use 51057R.....
499E	7288	Brace Bolt with 1522E, for 27006, obsolete.....
507E	4476	Bed Bracket Bolt with 1515E (Accessories).....
534E	7881	Brace Bolt with 1510E, for 25206 and 25207.....
559E	7870	Band Wheel Stud for 25206.....
56FC	4476	Feed Connecting Link Hinge Screw.....
565C	4476	" Forked Connection Hinge Screw.....
566C	4468	Needle Bar Connecting Link Hinge Screw..
567D	4477	Thread Take-up Lever Hinge Screw, obsolete.....
568E	4477	Feed Regulator Hinge Screw.....
575E	4476	Crank Connecting Rod Cap Screw for 19758
597C	4479	Driving Attachment Shaft Driving Pulley Clamping Screw for 9091 and 11864...
597C	4479	Pulley Clamping Screw for 27061.....
597C	4479	Under Driver Shaft Driving Pulley Clamping Screw for 11864.....
606E	4474	Thread Retaining Screw Stud for 58597...
607C	4473	Tension Screw Stud for 58598.....
608C	4466	Lifting Presser Bar Rock Shaft Eccentric Strap Hinge Screw.....
609D	4478	Lifting Presser Bar Spring Regulating Thumb Screw, obsolete.....
610D	4465	Lifting Presser Bar Bell Crank Lifting Roller Screw for 1851, obsolete....
610D	4465	Lifting Presser Bar Bell Crank Slide Block Screw for 58621.....
654C	4478	Oscillating Rock Shaft Hinge Pin Screw Bearing for 19790, obsolete.....
660D	4477	Shuttle Race Back Spring Screw for 19849
680F	4468	Needle Clamp Thumb Screw for 19702.....
692D	4479	Feed Lifting Rock Shaft Crank Clamping Screw for 19837.....
828C	4474	Thread Unwinder Tension Screw Stud for 42418.....
839R	7873	Journal Box Bracket Bolt with 1522E, for 126957.....
851E	4473	Spool Holder Tension Spool Pin with fixed cone, for 11881.....

NUMERICAL LIST OF PARTS

No.	Plate	Name
872E	4479	Arm Screw.....
885D	4477	Guide Thumb Screw.....
894E	4476	Bobbin Winder Base Screw for 60219, 60276, 60278 and 60279.....
898D	4476	Vibrating Presser Foot Screw.....
909C	22796	Balance Wheel Set Screw for 58563.....
949E	22796	Arm Shaft Screw.....
1015C	4478	Feed Lifting Rock Shaft Screw Center (left).....
1015C	4478	Feed Rock Shaft Screw Center (left)....
1036C	22796	Driving Attachment Brake Block Stud Set Screw for 58459.....
1114E	7873	Leg Foot Screw for 27042, obsolete.....
1151C	4476	Crank Connecting Rod Hinge Screw.....
1156C	4469	Oscillating Shaft Crank Slide Block Cap Screw Stud for 19773.....
1177D	4476	Lifting Presser Bar Spring Bracket Screw
1177D	4476	Spool Holder Bracket Screw.....
1259C	4478	Lifting Presser Foot Set Screw for 58260 and 58261.....
1323F	3564	Shuttle Tension Regulating Screw for 43246, 43288 and 58271.....
1402D	7871	Balance Wheel Ball Washer (right) Screw for 58336 and 58650.....
1402D	7871	Driving Attachment Balance Wheel Ball Washer (right) Screw for 58336 and 58650.....
1503E	4478	Band Wheel Stud Nut for 25206.....
1503E	4478	Feed Lifting Rock Shaft Screw Center (left) Nut.....
1503E	4478	Feed Lifting Rock Shaft Screw Center (right) Nut.....
1503E	4478	Feed Rock Shaft Screw Center (left) Nut.
1503E	4478	" " " " (right) Nut
1503J	4478	Oscillating Rock Shaft Hinge Pin Nut for 19790 and 58595.....
1503J	4478	Oscillating Rock Shaft Hinge Pin Screw Bearing Nut for 19790 and 58558.....
1507J	4479	Journal Box Set Screw Nut for 27025, 27026 and 27121.....
1507R	4479	Treadle Screw Center Nut for 46629 and 46661.....
1508E	4469	Oscillating Shaft Crank Slide Block Cap Screw Stud Nut for 19789.....
1510E	7881	Brace Bolt Nut for 534E.....
1513J	4479	Feed Bar Screw Center Nut.....
1513J	4479	" Connecting Link Hinge Screw Nut....
1513J	4479	" Forked Connection Hinge Screw Nut..
1513J	4479	Needle Bar Connecting Link Hinge Screw Nut.....

No.	Plate	Name
1515E	4479	Bed Bracket Bolt Nut for 507E.....
1518E	4465	Lifting Presser Bar Bell Crank Slide Block Screw Nut.....
1518D	4465	Lifting Presser Bar Rock Shaft Eccentric Strap Hinge Screw Nut.....
1515E	4465	Thread Take-up Lever Roller and Screw Stud Nut for 1995.....
1520E	4479	Driving Attachment Lever Spring Hook Nut for 19862, 58380 and 58655.....
1520R	4479	Under Driver Lever Stop Screw Nut for 60823.....
1522E	4479	Brace Bolt Nut for 499E, obsolete.....
1522E	4479	Driving Attachment Lever Bracket Bolt Nut for 497E.....
1522E	4479	Journal Box Bracket Bolt Nut for 489E, 492E and 839R.....
1522E	4479	Journal Box Hanger Bracket Bolt Nut for 497R and 51057R.....
1522E	4479	Leg Bolt Nut for 51057N.....
1522E	4479	" Cross Member Bolt Nut for 51057N....
1522E	4479	Rail Bolt Nut for 492E, obsolete.....
1522E	4479	Safety Guard Bracket Bolt Nut for 492E, obsolete.....
1528C	4479	Lifting Presser Bar Rock Shaft Eccentric Strap Adjusting Screw Nut for 11486.
1541E	4473	Spool Holder Tension Spool Pin Nut for 11881.....
1547D	4479	Vibrating Presser Foot Screw Nut.....
1560C	4473	Tension Regulating Thumb Nut for 58598..
1560C	4473	Thread Retaining Regulating Thumb Nut for 58597.....
1560C	4473	Thread Unwinder Tension Regulating Thumb Nut for 42418.....
1588C	7873	Leg Stay Rod Nut for 25328.....
1588R	7873	Under Driver Treadle Support Rod Nut 126618.....
1600E	7873	Table Clamp Bolt Nut for 51092P.....
1646E	4479	Crank Connecting Rod Hinge Screw Nut....
1796E	7978	Under Driver Belt Tightener Screw Nut for 126590.....
1850	4466	Lifting Presser Bar Rock Shaft Crank Roller and Stud for 11484.....
1851	4465	Lifting Presser Bar Bell Crank Lifting Roller with 610D, obsolete.....
1861	4475	Feed Lifting Rock Shaft Crank Roller and Stud for 19837.....
1948	4475	Thread Take-up Lever Thread Guiding Roller and Screw Stud for 19852 and 58308, obsolete.....
1995	4475	Thread Take-up Lever Roller and Screw Stud with 1518E, for 19852, 58308 and 58332.....

No.	Plate	Name
2002	4475	Lifting Presser Bar Rock Shaft Bracket Dowel Pin (lower).....
2022	4465	Feed Lifting Rock Shaft Wearing Block Position Pin for 9225.....
2049	4475	Lifting Presser Foot Pin, obsolete.....
2049	4475	Shuttle Race Back Position Pin for 19849
2102	4474	Thread Retaining Disc for 11503.....
2102	4474	" Unwinder Tension Disc for 60609..
2103	4474	" Retaining Spring for 11503.....
2103	4474	" Unwinder Tension Spring for 60609
2117	4475	Belt Shifter Slide Rod Pin for 19994....
2117	4475	Feed Rock Shaft Crank Pin, obsolete....
2117	4475	Lifting Presser Bar Rock Shaft Adjusting Arm Pin.....
2117	4475	Lifting Presser Bar Rock Shaft Crank Pin
2205	4468	Oil Cup Cover Latch Spring for 11921 and 58254.....
2269	4483	Bobbin Winder Stop Latch Pin for 60217.
2718	4465	Lifting Presser Bar Bell Crank Slide Block Screw Nut Washer.....
2718	4465	Driving Attachment Treadle Extension Screw Washer for 126037.....
2762	4483	Driving Attachment Treadle Stop Collar with 362C, for 27640, obsolete.....
2878	4481	Driving Attachment Treadle Stand for 27642, obsolete.....
3012	7871	Belt Shifter Guide Rod Pin for 19994....
4389	4475	Lifting Presser Bar Rock Shaft Bracket Dowel Pin (upper).....
4389	4475	Lifting Presser Bar Spring Guide Pin....
4784	4487	Bobbin Winder Frame Oil Pad (felt) for 60217.....
4879	7871	Belt Shifter Chain Connecting Link for 4885.....
4881	7876	Belt Shifter Treadle for 4885.....
4882	7871	" " " Shaft for 4885....
4883	7872	" " " Spring for 4885....
4884	7876	" " " Stand for 4885....
4885	7876	Belt Shifter Treadle complete for 19994, Nos. 4879, 4881 to 4884 and two wood screws 1 in. No. 16.....
5769	4474	Thread Unwinder Tension Thread Eyelet for 60609.....
5983	4473	Tension Friction Washer (felt) for 12042
6055	4483	Driving Attachment Lever Spring Hook Nut Washer for 19862, 58380 and 58655...
6055	4483	Driving Attachment Treadle Pitman Rod (lower) Spring Washer for 27640, ob- solete.....
6439	-----	Belt Shifter Chain, 36 in. to 45 in., with 56864 and 56865, for 19994....

NUMERICAL LIST OF PARTS

No.	Plate	Name
8018	4473	Spool Holder Tension Spool Pin Cone for 11881.....
8019	4473	Spool Holder Tension Spool Pin Spring for 11881.....
8482	4468	Oil or Wax Stripper Washer (steel) for 58253, for 11921 and 58254.....
8702	4475	Arm Dowel Pin.....
8708	4487	" Spool Pin, obsolete.....
8760	4465	Lifting Presser Bar Lifter Friction Washer.....
8761	4465	Lifting Presser Bar Lifter Stop Pin for 11909.....
8763	4465	Lifting Presser Bar Lifting Link Hinge Stud for 11909.....
8765	4487	Lifting Presser Bar Lifting Hinge Stud Washer, obsolete, use 43267.....
8776	3564	Shuttle Cylinder for 43246, obsolete....
8777	3564	" " Hinge Pin for 19844, 19976, 58210, 58323 and 58669.....
8778	3564	Shuttle Cylinder Latch Spring for 19989, obsolete.....
8780	3564	Shuttle Tension Spring for 43246, obsolete.....
8791	4474	Tension Spring for 12042.....
8804	7874	Belt Shifter Frame Handle for 11941.....
8873	4475	Balance Wheel Pin for 7-31 Machine, obsolete.....
8873	4475	Band Wheel Pin for 25207.....
8873	4475	" " Shaft Crank Pin for 25207....
8873	4475	Driving Attachment Balance Wheel Pin for 19862, obsolete.....
8873	4475	Oscillating Shaft Crank Pin.....
8873	4475	Shuttle Driver Pin.....
8873	4475	Thread Take-up Cam Pin.....
8873	4475	Treadle Shaft Crank Pin for 25207.....
8879	4483	Tension Friction Washer, obsolete.....
8905	4473	" Regulating Thumb Nut Washer for 12042.....
8905	4473	Thread Retaining Regulating Thumb Nut Washer for 11503.....
8908	4484	Wrench for 1520 (Accessories).....
8909	4484	" " 692, 1513, 1524 and 50323 (Accessories).....
8910	4484	Wrench for 1508 (Accessories).....
8911	4484	" " 1503 (Accessories).....
8953	4468	Oil or Wax Stripper (felt) for 11921 and 58254.....
8973	4465	Lifting Presser Bar Lifting Link Hinge Stud Pin.....
8984	4482	Driving Attachment Brake Block (wood) for 58286 and 58460.....

NUMERICAL LIST OF PARTS

No.	Plate	Name
8991	4482	Driving Attachment Lever Screw Washer for 58286 and 58460.....
8992	4482	Driving Attachment Lever Spring for 58286 and 58460.....
9079	4483	Driving Attachment Treadle Pitman Rod Clamp with 354C, obsolete, use 80223
9079	4483	Under Driver Treadle Pitman Rod Clamp with 354C, obsolete, use 80223.....
9082	4483	Driving Attachment Treadle Bearing Cotter Pin for 27642, obsolete.....
9084	4468	Oil Cup Cover Hinge Pin for 11921 and 58254.....
9091	4480	Driving Attachment Shaft Driving Pulley (sectional) 10 in. diam., 1 1/2 in. face, 1 3/16 in. bore, with two 597C, for 58380 and 58655.....
9093	4462	Feed Lifting Rock Shaft for 19836, obsolete.....
9115	4461	Oscillating Rock Shaft Hinge Pin for 19790, obsolete, superseded by 58552, not interchangeable.....
9121	4472	Shuttle Race Slide (right) for 19858....
9122	4472	" " " (left) for 19858.....
9137	7872	Belt Shifter Chain Pulley for 19994.....
9152	4469	Oscillating Shaft Collar with two 448C..
9219	7872	Thread Take-up Lever Thread Eyelet Bushing for 58332.....
9225	4461	Feed Lifting Rock Shaft with 134D, 2022 and 19967, for 58288.....
9281	7872	Leg Foot Screw Washer for 27042, obsolete
9296	7881	Pitman Stud for 25004.....
9525	4474	Thread Take-up Spring Staple Washer for 11501.....
9842	4475	Bobbin Winder Bracket Screw Washer for 60219, 60276, 60278 and 60279.....
9842	4475	Leg Foot Screw Washer for 126514.....
11044	4474	Tension Wheel for 12042.....
11107	4486	Bobbin Winder Stop Latch Hinge Pin for 60217.....
11165	4469	Oscillating Rock Shaft Oil Pad for 19790 and 58558.....
11241	4487	Arm Spool Pin Washer (cloth) obsolete...
11354	4463	" Shaft Bushing.....
11360	4482	Bed Bracket (right) with wood screw 1 in. No. 16, for machine on top of table (Accessories).....
11361	4482	Bed Bracket (left) with wood screw 1 in. No. 16, for machine on top of table (Accessories).....
11365	4464	Feed Bar.....

NUMERICAL LIST OF PARTS

No.	Plate	Name
11367	4463	Feed Cam with two 445C.....
11368	4465	" Connecting Link.....
11375	4464	" Regulator.....
11379	4487	" Rock Shaft Crank with 453C, for 19839, obsolete.....
11383	4468	Needle Bar Connecting Stud with two 445F
11385	4468	" Clamp Gib for 19702.....
11423	4473	Tension Friction Washer (steel) for 12042.....
11424	4474	Thread Eyelet for 11502.....
11438	-----	Balance Wheel with two 354C, for 7-31 Machine, obsolete.....
11440	4480	Driving Attachment Friction Pulley, 7 in. diam., 1 1/2 in. face, with 448C and 11441, for 19862 and 58380, ob- solete, superseded by 58653, not in- terchangeable.....
11441	4483	Driving Attachment Friction Pulley Cen- ter Bearing for 11440, obsolete, su- perseded by 58654, not interchange- able.....
11442	4480	Balance Wheel Friction Washer (paper) for 58336, obsolete, superseded by 58657, not interchangeable.....
11442	4480	Driving Attachment Balance Wheel Fric- tion Washer (paper) for 58336, obso- lete, superseded by 58657, not in- terchangeable.....
11442	4480	Driving Attachment Friction Pulley Wash- er (paper) for 58289, obsolete.....
11446	7871	Belt Shifter Chain Eyelet for 19994.....
11451	7874	" " Slide Rod for 19994.....
11453	7872	" " " " Spring Collar with two 448C, for 19994.....
11454	7874	Belt Shifter Slide Rod Spring for 19994.
11459	7872	" " Pulley (loose) Collar with two 448C, for 19994.....
11475	4482	Lifting Presser Bar, obsolete.....
11476	850	" " Bell Crank, obsolete, superseded by 58617, not inter- changeable.....
11478	850	Lifting Presser Bar Bracket with two 145D, obsolete, use 58643.....
11479	4466	Lifting Presser Bar Rock Shaft.....
11480	850	" " " " " Adjusting Arm with 453C, obsolete, use 58578..
11481	4463	Lifting Presser Bar Rock Shaft Bracket..
11484	4466	" " " " " Crank with 453C and 1850.....
11486	850	Lifting Presser Bar Rock Shaft Eccentric Strap with two each 141E and 1528C..

NUMERICAL LIST OF PARTS

No.	Plate	Name
11487	4466	Lifting Presser Bar Rock Shaft Eccentric Strap Hinge Screw Slide.....
11488	4466	Lifting Presser Bar Rock Shaft Eccentric Strap Hinge Screw Slide Washer.....
11489	4466	Lifting Presser Bar Sleeve (lower).....
11490	4466	" " " " (upper) for 11491.....
11491	-----	Lifting Presser Bar Sleeve (upper) 11490 with 11492.....
11492	4466	Lifting Presser Bar Sleeve (upper) Cap for 11491.....
11493	4461	Lifting Presser Bar Spring (flat).....
11494	850	" " " " Bracket with 12232, obsolete.....
11495	4468	Thread Eyelet (side of arm).....
11497	-----	Oil Cup for 11921, obsolete.....
11501	-----	Tension Bracket and Vibrating Presser Bar Cap complete, Nos. 122E, 9525, 11502, 11506, 11936, 11937, 12042 and two 190J.....
11502	4473	Tension Bracket and Vibrating Presser Bar Cap with 11424, for 11501.....
11503	-----	Thread Retainer complete, Nos. 2103, 8905, 58597 and two 2102.....
11505	4461	Thread Take-up Cam with two 434C.....
11506	4474	" " Spring for 11501.....
11508	850	Vibrating Presser Bar.....
11509	4475	" " " Cushion (rawhide).....
11510	850	" " " Hinge Bracket with 145E, obsolete, superseded by 58620, not interchangeable.....
11512	4475	Vibrating Presser Bar Spring.....
11538	4464	Needle Bar.....
11539	4468	" " Connecting Link.....
11743	7881	Pitman Washer for 25206 and 25207.....
11831	4484	Screw Driver, large (Accessories)....
11838	4475	Shuttle Race Frame Position Pin for 19850.....
11864	7879	Driving Attachment Shaft Driving Pulley (sectional) 10 in. diam., 1 1/4 in. face, 1 3/16 in. bore, with two 597C, for 19862, obsolete.....
11864	7879	Under Driver Shaft Driving Pulley (sec- tional) 10 in. diam., 1 1/4 in. face, 1 3/16 in. bore, with two 597C, for 126740.....
11879	-----	Spool Holder Bracket for 11880, obsolete
11880	-----	Spool Holder Bracket complete, Nos. 11879 and 11881, obsolete.....
11881	-----	Spool Holder Tension Spool Pin complete for 11880 and 58256, Nos. 851E, 1541E, 8018 and 8019.....

NUMERICAL LIST OF PARTS

No.	Plate	Name
11907	4463	Lifting Presser Bar Lifting Link.....
11909	4464	" " " Lifter with 8761 and 8763.....
11913	4462	Arm Side Cover.....
11917	-----	Oil Cup Cover for 11921 and 58254.....
11918	4468	" or Wax Stripper Washer (steel) for 11917, 11921 and 58254.....
11919	4468	Oil Cup Thread Eyelet for 11921, obsolete
11921	4461	Oil Cup complete, Nos. 2205, 8482, 9084, 11497, 11917, 11918, two 8953 and three 207F, obsolete.....
11936	4474	Thread Take-up Spring Regulator Plate for 11501.....
11937	4474	Thread Take-up Spring Staple for 11501..
11939	4475	Vibrating Presser Bar Spring Adjusting Staple.....
11940	7878	Belt Shifter Fork for 19994.....
11941	7876	" " Frame with 8804 and two 434C, for 19994.....
11950	4474	Thread Eyelet for 11503.....
12042	-----	Tension (wheel) complete for 11501, Nos. 8791, 8905, 11044, 11423, 58598 and two 5983.....
12232	4487	Lifting Presser Bar Spring Guide Pin for 11494, obsolete.....
12620	7288	Brace Bolt Nut Washer for 27006, obsolete
12620	7288	" " Washer for 27006, obsolete...
12620	7288	Journal Box Bracket Bolt Nut Washer for 27018 and 27043.....
12620	7288	Journal Box Bracket Bolt Washer for 27043, obsolete.....
12620	7288	Journal Box Hanger Bracket Bolt Nut Washer for 126957.....
12620	7288	Leg Cross Member Bolt Nut Washer for 126514.....
12620	7288	Leg Bolt Nut Washer for 126514.....
12620	7288	Rail Bolt Nut Washer for 27095, obsolete
12620	7288	" " Washer for 27095, obsolete....
12620	7288	Safety Guard Bracket Bolt Nut Washer for 41300, obsolete.....
12620	7288	Safety Guard Bracket Bolt Washer for 41300, obsolete.....
14785	4482	Driving Attachment Lever Spring Hook (for machine on top of table) for 19862, 58380 and 58655.....
*15404	-----	Trade Mark for 58257.....
15405	7871	Bobbin Winder Friction Pulley Ring Rivet, obsolete, use 26070.....
15405	7871	Trade Mark Rivet for 58257.....
16901	3563	Shuttle Bobbin for 19844, 19976, 58210, 58323 and 58669.....

NUMERICAL LIST OF PARTS

No.	Plate	Name
17547	4474	Thread Unwinder Tension Thread Guard for 60609.....
19663	4480	Driving Attachment Lever Bracket for 58286, obsolete, use 58462.....
19702	4468	Needle Clamp with 680F and 11385.....
19703	4487	Vibrating Presser Foot for 19835, obsolete, superseded by 58262, not interchangeable.....
19747	7875	Arm Shaft for 7-41 Machine.....
19748	4461	" " " 7-31 Machine, obsolete, use 58587.....
19758	4462	Crank Connecting Rod with two 575E.....
19762	4461	Feed Forked Connection.....
19768	4461	Oscillating Rock Shaft for 19790, obsolete, superseded by 58550, not interchangeable.....
19770	-----	Oscillating Shaft Crank with 445C, for 19789.....
19771	4469	Oscillating Shaft Crank Slide Block for 19773.....
19772	4469	Oscillating Shaft Crank Slide Block Cap Screw Washer for 19773.....
19773	4469	Oscillating Shaft Crank Slide Block complete for 19789, Nos. 164E, 1156C, 19771 and 19772.....
19789	4469	Oscillating Shaft Crank complete, Nos. 1508E, 19770 and 19773.....
19790	-----	Oscillating Rock Shaft Crank complete, Nos. 654C, 9115, 11165, 19768 and two 1503J, obsolete, superseded by 58558, not interchangeable.....
*19831	-----	Arm for 11494, 11497 and 11879, obsolete
*19832	-----	Bed.....
19833	-----	Cloth Plate, obsolete, use 58222.....
19834	4436	Feed Dog (double).....
19835	4437	" " (single).....
19836	-----	Feed Lifting Rock Shaft complete, Nos. 9093 and 19837, obsolete, use 58288.
19837	4463	Feed Lifting Rock Shaft Crank with 692D and 1861, for 19836 and 58288.....
19838	4461	Feed Rock Shaft for 19839, obsolete.....
19839	-----	Feed Rock Shaft complete, Nos. 11379 and 19838, obsolete, use 58244.....
19840	4487	Lifting Presser Foot with 211F, for 19834, obsolete.....
19841	4487	Lifting Presser Foot with 211F, for 19835, obsolete.....
19842	4461	Oscillating Shaft.....
19843	3564	Shuttle Frame for 19989, obsolete.....
19844	3563	Shuttle (cylinder) 4 in. diam., complete, Nos. 9777, 16901, 19989 and 43246, obsolete, use 19976.....

No.	Plate	Name
19845	4472	Shuttle Driver with 4450.....
19846	4441	" Race Back for 19849.....
19847	4441	" " " Spring for 19849.....
19848	-----	" " " Body for 19849.....
19849	4441	Shuttle Race complete, Nos. 660D, 19846 to 19848 and two 2049.....
19850	4462	Shuttle Race Frame with 11838.....
19852	4482	Thread Take-up Lever with 1948 and 1995, obsolete.....
19853	-----	Throat Plate Body for 19855.....
19854	4436	" " Needle Hole Strip for 19855
19855	4436	Throat Plate complete for 19834, Nos. 19853, 19854 and two 389F.....
19856	-----	Throat Plate Body for 19858.....
19857	4437	" " Needle Plate for 19858.....
19858	4437	Throat Plate complete for 19835, Nos. 231F, 19856 and 19857.....
19859	4482	Vibrating Presser Bar for 19703, obsolete
19860	4467	" " Foot for 19834.....
19862	-----	Driving Attachment complete for 7-31 Machine, Nos. 1520E, 6055, 8873, 11440, 11864, 14785, 58286, 58289 and 126210, obsolete.....
19863	4482	Driving Attachment Lever Spring Hook (for machine flush with table) for 19862, 58380 and 58655.....
19869	4471	Shuttle Cylinder Latch Spring for 58206 and 58272, obsolete, use 58666.....
19923	7875	Arm Shaft for 7-33 Machine.....
19967	4465	Feed Lifting Rock Shaft Wearing Block for 9225.....
19975	4488	Shuttle Frame for 58206, obsolete.....
19976	-----	Shuttle (cylinder) 4 in. diam., complete, Nos. 8777, 16901, 43246 and 58206, obsolete, use 58210.....
19989	-----	Shuttle Frame 19843 with 330D and 8778, for 19844, obsolete.....
19991	7879	Balance Wheel and Pulley (tight) with two 354C, for 19994, for 7-41 Machine.....
19992	7874	Belt Shifter Guide Rod for 19994.....
19993	7876	" " Pulley (loose) for 19994...
19994	-----	Belt Shifter complete for 7-41 Machine, Nos. 10D, 2117, 3012, 4885, 6439, 9137, 11446, 11451, 11453, 11454, 11459, 11940, 11941 and 19991 to 19993.....
23258	7871	Driving Attachment Treadle Bracket (left) Hook Friction Washer for 126206.....
23535	4484	Wrench for 346, 1528 and 1547 (Accessories).....

No.	Plate	Name
25004	7882	Band Wheel (two speed) 11 15/16 in. and 14 3/16 in. diam., with 9296, for 25206.....
25011	7881	Band Wheel Stud Screw Washer for 25206..
25012	-----	Belt, size 3/8 in., length 80 1/2 in., with 25030, for 25206.....
25013	-----	Belt, size 3/8 in., length 86 1/2 in., with 25030, for 25207.....
25029	7871	Belt Hook for 41161.....
25030	7881	" " " 25012 and 25013.....
25034	1860	Brace with two 46629, for 25206.....
25061	1860	Leg (left) for 25206.....
25062	1860	" (right) for 25206.....
25073	7882	Pitman (wood) for 25206.....
25080	7882	Treadle with two each 164D, 25085 and 41544, for 25206.....
25085	-----	Treadle Strap (leather) for 25080.....
25086	7870	Wrench for 1507 and 1510.....
25087	4460	Band Wheel (two speed) 12 in. and 14 in. diam., with 25088, for 25207.....
25088	7881	Pitman Stud for 25087 and 25091.....
25089	7881	" Cotter Pin for 25206 and 25207...
25090	4460	Band Wheel Shaft for 25207.....
25091	7870	" " " Crank with 355C and 25088, for 25207.....
25091	7870	Treadle Shaft Crank with 355C and 25088, for 25207.....
25093	4459	Brace with 448C, for 25207.....
25094	4459	Leg for 25207.....
25095	4460	Pitman with four wood screws 1 1/8 in. No. 6 R.H.B. for 25207.....
25096	7875	Treadle with four 129E, for 25207.....
25097	4460	" Shaft for 25207.....
25098	7870	" " Bushing for 25207.....
25099	7881	" " Collar with 448C, for 25207.....
25114	7881	Band Wheel Stud Washer for 25206.....
25206	-----	Stand (iron work) rocking treadle, complete, for 7-33 Machine, Nos. 150D, 559E, 1503E, 25004, 25011, 25034, 25061, 25062, 25073, 25080, 25114, two each 11743, 25089 and four 534E.....
25207	-----	Stand (iron work) rotary treadle, complete, for 7-33 Machine, Nos. 25087, 25090, 25093, 25097 to 25099, 25328, two each 25094 to 25096, three 25091 and four each 534E, 8873, 11743 and 25089.
25303	7978	Under Driver Driving Pulley Shaft Ball, size 1/4 in., for 126576.....
25326	4460	Leg Stay Rod for 25328.....
25327	7881	" " " Nut Packing for 25328.....

No.	Plate	Name
25328	-----	Leg Stay Rod complete for 25207, Nos. 25326 and two each 1588C and 25327..
25362	7978	Balance Wheel Ball, size 3/16 in., for 58651 and 122304.....
25362	7978	Driving Attachment Balance Wheel Ball, size 3/16 in., for 58651 and 122304.
25362	7978	Under Driver Friction Pulley Ball, size 3/16 in., for 227553.....
25446	7872	Under Driver Treadle Support Rod Nut Washer for 126618.....
26026	4484	Screw Driver, small (Accessories).....
26070	22796	Bobbin Winder Friction Pulley Ring Rivet for 43270.....
26419	4463	Guide (6 in. face) for 19858.....
27006	4480	Brace (table) 27279 with 499E and two each 12620 and wood screws 1 1/2 in. No. 14, for 41163 and 41164,obsolete
27015	7878	Floor Stand or Hanger Foot, 5 in., with six wood screws 1 1/2 in. No. 16,for 27018.....
27018	-----	Floor Stand complete for 126618 and 126619, Nos. 492E,12620,27015,27022, 27026 and 27028.....
27022	4481	Journal Box with 27029,27030,41157,41158 and two 121E, for 27018, 27043 and 126505.....
27025	4481	Journal Box Bracket, 6 in. drop, with 421E and 1507J, for 27043, obsolete.
27026	7878	Journal Box Bracket, 6 in. high, with 421E and 1507J, for 27018.....
27028	4481	Journal Box Bracket Adjusting Slide for 27018 and 27043.....
27029	4483	Journal Box Oil Feeder (felt) for 27022.
27030	-----	" " " Reservoir for 27022.....
27042	4480	Leg, 25 1/2 in. wide, with four each 1114E and 9281, for 27043 and 41163, obsolete.....
27043	-----	Leg complete for 41164, Nos. 489E,27022, 27025,27028,27042 and two each 12620 and 41300, obsolete,use 126210
27061	4480	Pulley (sectional) 6 in. diam., 1 1/4 in. face, 1 3/16 in. bore, with two 597C, for 41164 and 126620.....
27095	4480	Rail, 30 in., single flat, with two 492E, four each 12620, wood screws 1 in. No. 10 and eight wood screws 1 1/2 in. No. 14, for 41163 and 41164, obsolete.....
27104	7876	Safety Guard Bracket (left) for 41300, obsolete.....

No.	Plate	Name
27105	7876	Safety Guard Bracket (right) for 41300, obsolete.....
27108	4461	Shaft Collar with 432C, for 41164 and 126618 to 126620.....
27121	7878	Journal Box Bracket, 8 in. drop, with 421E and 1507J, for 126505.....
27279	-----	Brace (table) for 27006, obsolete.....
27414	7978	Under Driver Driving Pulley Spring, obsolete, superseded by 126895, not interchangeable.....
27555	7285	Thread Unwinder Spool Pin for 27555.....
27556	-----	" " " Rest 27583 with 138B and two 27555, for 41823 and 60637.....
27557	7285	Thread Unwinder Spool Stand with 138B, for 41823.....
27560	7285	Thread Unwinder Thread Guard Rod, 26 in. long,for 41823.....
27583	7285	Thread Unwinder Spool Rest for 27556,...
27636	4481	Driving Attachment Treadle for 27642,obsolete.....
27637	4462	Driving Attachment Treadle Pitman Rod (lower) for 27640, obsolete.....
27638	4462	Driving Attachment Treadle Pitman Rod (lower) Spring, obsolete, use 150208
27639	4462	Driving Attachment Treadle Pitman Rod for 60626.....
27639	4462	Driving Attachment Treadle Pitman Rod (upper) for 27640, obsolete.....
27639	4462	Under Driver Treadle Pitman Rod for 60626.....
27640	4462	Driving Attachment Treadle Pitman complete for 27643 and 126210, Nos. 2762, 6055, 27637, 27639, 80223 and 150208, obsolete.....
27642	-----	Driving Attachment Treadle complete for 27643, Nos. 2878,9082,27636 and four wood screws 1 in. No. 16, obsolete..
27643	-----	Driving Attachment Treadle and Pitman complete for 19862, Nos. 27640 and 27642, obsolete.....
27693	7882	Thread Unwinder Thread Guard Rod, 37 in. long, for 60637.....
36114	4456	Guide (6 in. face) for 19855.....
40063	7980	Under Driver Frame Hinge Pin for 126590.
41124	4480	Bridle Iron with four each 41125 and 51080E, for 5283, 5376, 29707, 29708 and 29711 (Accessories).....
41125	4483	Bridle Iron Bolt Washer for 41124.....
*41157	-----	Journal Box Bottom for 27022.....

No.	Plate	Name
*41158	-----	Journal Box Top for 27022.....
41161	-----	Belt, size 5/16 in., length 55 3/4 in., with 25029, for 126618.....
41163	-----	Iron Work complete for 5283, two each Nos. 27006, 27042 and 27095, obsolete
41164	-----	Iron Work complete for 5376, Nos. 27061, two each 27006, 27043, 27095, 27108, four feet two inches of 1 3/16 in. shafting and thirteen feet of 1 in. flat belting, obsolete.....
41300	-----	Safety Guard Bracket complete for 5376, for 27043, Nos. 492E, 27104, 27105 and two 12620, obsolete.....
41441	4485	Bobbin Winder Frame Hinge Pin for 60217.
41544	4475	Treadle Strap Screw Washer for 25080....
41544	4475	Vibrating Presser Bar Hinge Cap Screw Washer.....
41823	7285	Thread Unwinder complete, for two large spools, for 60219, 60276, 60278 and 60279, Nos. 27556, 27557, 27560, 60609 and three wood screws 1 1/4 in. No. 12.....
41894	4485	Bobbin Winder Base with 449C, for 60217.
41896	4485	" " Frame for 60217.....
41897	4485	" " " Spring for 60217....
41899	4486	" " Tripping Arm with 176E, for 60217.....
42418	-----	Thread Unwinder Tension Screw Stud 828C with 156CC, for 60609.....
43235	4471	Shuttle Cylinder Latch for 58206 and 58272, obsolete, use 58644.....
43236	4471	Shuttle Cylinder Latch Hinge Pin for 58206, 58272 and 58668.....
43246	-----	Shuttle Cylinder 8776 with 1323F and 8780, for 19844 and 19976, obsolete.
43267	4465	Lifting Presser Bar Lifting Link Hinge Stud Washer.....
43270	4486	Bobbin Winder Friction Pulley with 43271, two 448C and ten 26070, for 60217...
43271	4486	Bobbin Winder Friction Pulley Ring (leather) for 43270.....
43273	7871	Shuttle Bobbin Center Pin for 43284, ob- solete.....
43284	7870	Shuttle Cylinder with 43273, for 43288, obsolete, use 58207.....
43288	-----	Shuttle Cylinder 43284 with 1323F and 58209, for 58323, obsolete, use 58271.....
46629	-----	Treadle Screw Center 297C with 1507R, for 25034.....

No.	Plate	Name
46661	-----	Treadle Screw Center 296C, with 1507R, obsolete, use 46629.....
46681	7876	Driving Attachment Treadle Bracket (right) for 60502.....
49095	22796	Arm Shaft Screw Washer.....
49191	22796	Oscillating Rock Shaft Oil Tube Sleeve for 58559.....
50058R	7978	Under Driver Belt Guard Screw for 126791
50083C	22796	Lifting Presser Bar Bell Crank Hinge Stud Set Screw.....
50124D	4479	Bobbin Winder Bracket Screw for 60219, 60276, 60278 and 60279.....
50288C	7978	Under Driver Belt Tightener Screw Hinge Stud Set Screw for 126583.....
50288C	7978	Under Driver Frame Hinge Pin Set Screw for 126583.....
50322D	4477	Feed Regulator Thumb Screw.....
50323D	4479	Lifting Presser Bar Spring Regulating Thumb Screw.....
50356C	4478	Feed Bar Screw Center.....
50437D	4477	Thread Take-up Lever Hinge Screw.....
50512E	7978	Under Driver Pulley Screw for 126179....
50581R	7873	Driving Attachment Treadle Extension Screw for 126037.....
50959C	7978	Under Driver Driving Pulley Shaft Set Screw for 126586.....
51038E	7873	Leg Foot Screw for 126514.....
51057N	7873	" Bolt with 1522E, for 126514.....
51057N	7873	" Cross Member Bolt with 1522E, for 126514.....
51057R	7873	Journal Box Hanger Bracket Bolt with 1522E, for 126957.....
51067C	7978	Under Driver Brake Lever Set Screw for 126574 and 126791.....
51080E	7873	Bridle Iron Bolt with 51578E, for 41124.
51092P	7873	Table Clamp Bolt with 1600E, for 126612.
51227C	22796	Oscillating Rock Shaft Hinge Pin Screw Bearing for 58558.....
51578E	7873	Bridle Iron Bolt Nut for 51080E.....
55767	7978	Under Driver Belt Tightener Screw Hinge Stud for 126590.....
56864	7871	Belt Shifter Chain Hook (large) for 6439
56865	7871	" " " " (small) for 6439
58206	-----	Shuttle Frame 19975 with 19869, 43235 and 43236, for 19976, obsolete.....
58207	4470	Shuttle Cylinder for 58271.....
58208	4470	" Frame for 58272, obsolete, super- seded by 58667, not interchangeable.
58209	4471	Shuttle Tension Spring for 43288 and 58271.....

From the library of: Diamond Needle Corp

NUMERICAL LIST OF PARTS

No.	Plate	Name
58210	4471	Shuttle (cylinder) 4 in. diam., complete, Nos. 8777,16901,58271 and 58272, obsolete, use 58323.....
58221	-----	Cloth Plate Packing Rivet for 58222.....
58222	4462	" " with four 58221, for 19855..
58235	4465	Feed Rock Shaft Crank with 346E, for 58244.....
58243	4461	Feed Rock Shaft for 58244.....
58244	-----	Feed Rock Shaft complete, Nos. 58235 and 58243.....
58247	4480	Balance Wheel with two 354C, for 7-31 Machine, obsolete.....
58247	4480	Driving Attachment Balance Wheel with two 354C, for 58289, obsolete.....
58248	4480	Driving Attachment Lever for 58286, obsolete, use 58459.....
58249	7879	Balance Wheel (two speed) with two 354C, for 7-33 Machine, obsolete, superseded by 58563, not interchangeable.
58252	4463	Lifting Presser Bar Spring Bracket.....
58253	-----	Oil Cup for 58254.....
58254	4462	Oil Cup complete, Nos. 2205, 8482, 9084, 11917,11918,58253,two 8953 and three 207F.....
58255	4472	Spool Holder Bracket for 58256.....
58256	4472	Spool Holder Bracket complete, Nos.11881 and 58255.....
*58257	-----	Arm with 15404 and two 15405.....
58258	4464	Lifting Presser Bar.....
58259	4466	" " " Rock Shaft Eccentric Strap Hinge Screw Slide Stop.....
58260	4467	Lifting Presser Foot with 1259C, for 19834.....
58261	4467	Lifting Presser Foot with 1259C, for 19835.....
58262	4467	Vibrating Presser Foot for 19835.....
58263	7876	Table Belt Guide Bracket with 448C, for 58268.....
58264	7876	Table Belt Guide Pulley for 58268.....
58265	7874	" " " " Shaft with 58266 and 58267, for 58268.....
58266	7872	Table Belt Guide Pulley Shaft Oil Hole Plug for 58265.....
58267	-----	Table Belt Guide Pulley Shaft Packing (wick) for 58265.....
58268	-----	Table Belt Guide complete for 29711, for 7-31 Machine, Nos. 58264, 58265, two 58263 and eight wood screws 1 1/2 in. No. 14 R.H.B.....
58271	-----	Shuttle Cylinder 58207 with 1323F and 58209, for 58210 and 58669.....

NUMERICAL LIST OF PARTS

No.	Plate	Name
58272	-----	Shuttle Frame 58208 with 19869, 43235 and 43236, for 58210 and 58323, obsolete, use 58666.....
58286	-----	Driving Attachment Lever 58248 with 9D, 134D, 8984, 8991, 8992, 19663 and two 497E, for 19862 and 58380, obsolete, use 58460.....
58288	-----	Feed Lifting Rock Shaft complete, Nos. 9225 and 19837.....
58289	-----	Driving Attachment Balance Wheel 58247 with 11442 and four 401E, for 19862, obsolete.....
58307	-----	Thread Take-up Lever for 58308, obsolete
58308	4472	" " " 58307 with 1948 and 1995, obsolete, use 58332.....
58323	7870	Shuttle (cylinder) 4 in. diam.,complete, Nos. 8777,16901,43288 and 58272, obsolete, use 58669.....
*58331	-----	Thread Take-up Lever for 58332.....
58332	7874	" " " 58331 with 1995 and 9219.....
58334	7875	Arm Shaft for 7-31 Machine, obsolete,use 58588.....
58335	7879	Balance Wheel with two 354C, for 58336, obsolete, superseded by 58649, not interchangeable.....
58335	7879	Driving Attachment Balance Wheel with two 354C, for 58336, obsolete, superseded by 58649, not interchangeable.....
58336	-----	Balance Wheel 58335 with 11442, 122469, two 1402D and four 401J, for 7-31 Machine, obsolete, superseded by 58650, not interchangeable.....
58336	-----	Driving Attachment Balance Wheel 58335 with 11442,122469,two 1402D and four 401J, for 58380, obsolete, superseded by 58650, not interchangeable.
58380	-----	Driving Attachment complete for 7-31 Machine, Nos. 1520E,6055,9091,11440, 14785,58286,58336,122304,122306 and 126210, obsolete, superseded by 58655, not interchangeable.....
58411	7879	Balance Wheel with two 354C, for Under Driver, for 7-33 Machine.....
58458	22796	Driving Attachment Brake Block Stud for 58459.....
58459	22798	Driving Attachment Lever with 1036C and 58458, for 58460.....
58460	-----	Driving Attachment Lever 58459 with 134D, 8984, 8991, 8992, 58462 and two 497E, for 58655.....

NUMERICAL LIST OF PARTS

No.	Plate	Name
58462	22797	Driving Attachment Lever Bracket for 58460.....
58550	22797	Oscillating Rock Shaft for 58558.....
58552	22796	" " " Hinge Pin for 58595.....
58554	22796	Oscillating Rock Shaft Oil Tube Joint for 58560.....
58558	-----	Oscillating Rock Shaft complete, Nos. 1503J, 11165, 51227C, 58550, 58560 and 58595.....
58559	22796	Oscillating Rock Shaft Oil Tube with 49191, for 58560.....
58560	22796	Oscillating Rock Shaft Oil Tube and Joint complete for 58558, Nos. 58554, 58559 and 68350.....
58563	22798	Balance Wheel (two speed) with two 909C, for Stand for 7-33 Machine.....
58578	22796	Lifting Presser Bar Rock Shaft Adjusting Arm with 453C.....
58587	22798	Arm Shaft for 7-31 Machine, obsolete....
58588	-----	" " " 7-31 Machine, obsolete, superseded by 58648, not interchangeable.....
58595	-----	Oscillating Rock Shaft Hinge Pin 58552 with 1503J, for 58558.....
58597	-----	Thread Retaining Screw Stud 606E with 1560C, for 11503.....
58598	-----	Tension Screw Stud 607C with 1560C, for 12042.....
58617	22797	Lifting Presser Bar Bell Crank.....
58618	22796	" " " " " Hinge Stud
58619	22796	" " " " " Slide Block for 58621.....
58620	22797	Vibrating Presser Bar Hinge Bracket with 145E.....
58621	-----	Lifting Presser Bar Bell Crank Slide Block 58619 with 610D.....
58643	22797	Lifting Presser Bar Bracket with two 145E.....
58644	22795	Shuttle Cylinder Latch for 58668.....
58648	22798	Arm Shaft for 7-31 Machine.....
58649	22798	Balance Wheel with two 354C, for 58650..
58649	22798	Driving Attachment Balance Wheel with two 354C, for 58650.....
58650	-----	Balance Wheel 58649 with 58657, 122469, two 1402D and four 401J, for 7-31 Machine.....
58650	-----	Driving Attachment Balance Wheel 58649 with 58657, 122469, two 1402D and four 401J, for 58655.....

NUMERICAL LIST OF PARTS

No.	Plate	Name
58651	22796	Balance Wheel Ball Ring with eighteen 25362, for 7-31 Machine.....
58651	22796	Driving Attachment Balance Wheel Ball Ring with eighteen 25362, for 58655.
58652	22796	Balance Wheel Ball Washer (left) for 7-31 Machine.....
58652	22796	Driving Attachment Balance Wheel Ball Washer (left) for 58655.....
58653	22798	Driving Attachment Friction Pulley 7 in. diam. 1 1/2 in. face with 448C and 58654, for 58655.....
58654	22798	Driving Attachment Friction Pulley Center Bearing for 58653.....
58655	-----	Driving Attachment complete for 7-31 Machine, Nos. 1520E, 6055, 9091, 14785, 58460, 58650 to 58653 and 126212.....
58657	22798	Balance Wheel Friction Washer (paper) for 58650.....
58657	22798	Driving Attachment Balance Wheel Friction Washer (paper) for 58650.....
58666	22795	Shuttle Cylinder Latch Spring for 58668
58667	22795	" Frame for 58668.....
58668	-----	" " 58667 with 43236, 58644 and 58666, for 58669.....
58669	22795	Shuttle (cylinder) 4 in. diam. complete, Nos. 8777, 16901, 58271, 58668 and 120571.....
60213	4483	Bobbin Winder Bobbin Position Pin for 60215.....
60214	4486	Bobbin Winder Spindle for 60217.....
60215	4486	" " " Shaft with 454C and 60213, for 60217.....
60216	4486	Bobbin Winder Stop Latch for 60217.....
60217	4485	Bobbin Winder for 60219, 60276, 60278 and 60279, Nos. 2269, 11107, 41441, 41894, 41896, 41897, 41899, 43270, 60214 to 60216 and two 4784.....
60218	4481	Bobbin Winder Bracket for 60219.....
60219	-----	Bobbin Winder (swinging automatic, left hand) complete for 7-31 Machine, Nos. 9842, 41823, 50124D, 60217, 60218 and three 894E.....
60227	22797	Bobbin Winder Bracket for 60279.....
60264	22797	" " " " 60278.....
60274	22797	" " " " 60276.....
60276	-----	Bobbin Winder (swinging automatic, left hand) complete for 16901, for 58411, for 7-33 Machine, Nos. 9842, 41823, 50124D, 60217, 60274 and three 894E.

No.	Plate	Name
60278	-----	Bobbin Winder (swinging automatic, left hand) complete for 16901, for 7-41 Machine, Nos. 9842, 41823, 50124D, 60217, 60264 and three 894E.....
60279	-----	Bobbin Winder (swinging automatic, left hand) complete for 16901, for 58563, for 7-33 Machine, Nos. 9842, 41823, 50124D, 60217, 60227 and three 894E.
60502	-----	Driving Attachment Treadle Bracket (right) 46681 with two wood screws 1 in. No. 14, for 126209 and 126211...
60608	7285	Thread Unwinder Thread Guard for 60609..
60609	-----	Thread Unwinder Thread Guard complete for 41823 and 60637, Nos. 330E, 2103, 5769, 17547, 42418, 60608 and two 2102.
60626	7875	Driving Attachment Treadle Pitman complete for 126212, Nos. 80223 and two 27639.....
60626	7875	Under Driver Treadle Pitman complete for 126739, two each Nos. 80223 and two 27639.....
60636	7878	Thread Unwinder Holder with 138B, for 60637.....
60637	-----	Thread Unwinder complete, for two large spools of thread, for 5201, for 25207, Nos. 27556, 27693, 60609, 60636 and two wood screws 1 1/4 in. No. 12.....
60823	-----	Under Driver Lever Stop Screw 423C with 1520R, for 126791.....
60858	7870	Driving Attachment Treadle Hanging Hook for 126212.....
60911	7877	Under Driver Driving Pulley Friction Ring (leather) for 126169.....
60935	7978	Under Driver Driving Pulley Friction Ring Stop Pin for 126169.....
68350	22796	Oscillating Rock Shaft Oil Tube Oil Cup for 58560.....
80223	22796	Driving Attachment Treadle Pitman Rod Clamp with 361C, for 27640 and 60626
120344	4484	Oiler (copper plated) with 120345 (Accessories).....
120345	4484	Oiler Spout, 4 1/2 in. long, for 120344.
120571	22795	Shuttle Cylinder Opener for 58669.....
122303	-----	Balance Wheel Ball Ring for 122304, obsolete.....
122303	-----	Driving Attachment Balance Wheel Ball Ring for 122304, obsolete.....
122304	7874	Balance Wheel Ball Ring 122303 with eighteen 25362, for 7-31 Machine, obsolete, superseded by 58651, not interchangeable.....

No.	Plate	Name
122304	7874	Driving Attachment Balance Wheel Ball Ring 122303 with eighteen 25362, for 58380, obsolete, superseded by 58651, not interchangeable.....
122306	7874	Balance Wheel Ball Washer (left) for 7-31 Machine, obsolete, superseded by 58652, not interchangeable.....
122306	7874	Driving Attachment Balance Wheel Ball Washer (left) for 58380, obsolete, superseded by 58652, not interchangeable.....
122307	7874	Balance Wheel Ball Washer (right) obsolete, superseded by 122469, not interchangeable.....
122307	7874	Driving Attachment Balance Wheel Ball Washer (right) obsolete, superseded by 122469, not interchangeable.....
122469	22796	Balance Wheel Ball Washer (right) for 58336 and 58650.....
122469	22796	Driving Attachment Balance Wheel Ball Washer (right) for 58336 and 58650.
123183	7978	Under Driver Lever Shaft Cotter Pin for 126590.....
126036	7878	Driving Attachment Treadle for 126037 and 126209.....
126037	-----	Driving Attachment Treadle 126036 with 2718, 50581R and 126038, for 126211.
126038	7876	Driving Attachment Treadle Extension for 126037.....
126079	7871	Table Clamp Bolt Nut Lock Washer for 126612.....
126169	7877	Under Driver Driving Pulley (right hand) 6 3/4 in. diam., with 60911, 60935, 126202 and two 126895, for 126590..
126173	7978	Under Driver Driving Pulley Shaft Oiling Leather for 126577.....
126175	7978	Under Driver Driving Pulley Shaft Oiling Leather Plug (leather) for 126577...
126179	7877	Under Driver Friction Pulley (right hand) with 227553 and four 50512E, for 126590.....
126201	7979	Under Driver Driving Pulley Spring Retaining Washer for 126202.....
126202	-----	Under Driver Driving Pulley Spring Retaining Washer complete for 126169, Nos. 126201 and 126203.....
126203	7978	Under Driver Driving Pulley Spring Retaining Washer Pin for 126202.....
126205	7876	Driving Attachment Treadle Bracket (left) for 126206.....

No.	Plate	Name
126206	-----	Driving Attachment Treadle Bracket (left) complete for 126209 and 126211, Nos. 23258, 126205, 126207, 126208 and two wood screws 1 in. No. 14.....
126207	7871	Driving Attachment Treadle Bracket (left) Hook for 126206.....
126208	7871	Driving Attachment Treadle Bracket (left) Hook Rivet for 126206.....
126209	-----	Driving Attachment Treadle complete for 126210, Nos. 60502, 126036 and 126206, obsolete.....
126210	-----	Driving Attachment Treadle and Pitman complete for 19862 and 58380, Nos. 27640 and 126209, obsolete.....
126211	-----	Driving Attachment Treadle complete for 126212, Nos. 60502, 126037 and 126206
126212	-----	Driving Attachment Treadle and Pitman complete for 58655, Nos. 60626, 60858 and 126211.....
126501	7871	Table Clamp for 126612.....
126504	7876	Journal Box Hanger Bracket for 126957...
126505	-----	Journal Box Hanger Bracket complete for 126618 to 126620, Nos. 27022, 27121 and 126957.....
126508	7880	Leg for 126514.....
126509	7871	Journal Box Hanger Bracket Bolt Socket Washer for 126957.....
126509	7871	Leg Bolt Nut Socket Washer for 126514...
126509	7871	" Cross Member Bolt Nut Socket Washer for 126514.....
126512	7880	Leg Cross Member, 25 1/4 in. long, for 126514.....
126514	-----	Leg with Rail complete for 126616 and 126618 to 126620, Nos. 126512, 126516, two 126508 and four each 9842, 12620, 51038E, 51057N and 126509.....
126516	7880	Rail, 32 3/8 in. long, for 126514.....
126572	7980	Under Driver Belt Guard for 126590.....
126573	7978	" " Brake (thermoid) for 126590
126574	7877	" " Lever with 51067C, obsolete, superseded by 126791, not interchangeable.....
126575	7980	Under Driver Brake Lever Spring for 126590.....
126576	-----	Under Driver Driving Pulley Shaft (hollow) 126756 with 204107, 204108 and eleven 25303, for 126577.....
126577	-----	Under Driver Driving Pulley Shaft complete for 126590, Nos. 126173, 126175, 126576, 126578 and 126757.....

No.	Plate	Name
126578	7980	Under Driver Driving Pulley Shaft Oil Wick for 126577.....
126580	7874	Under Driver Lever Shaft for 126590.....
126583	7877	" " Base with two 50288C, for 126590.....
126584	7980	Under Driver Belt Tightener Screw for 126590.....
126585	7979	Under Driver Belt Tightener Screw Nut Washer for 126590.....
126586	7877	Under Driver Frame with 50959C, for 126590.....
126587	-----	Under Driver Pulley (flat) 3 in. diam., for 126590.....
126588	7877	Under Driver Pulley (flat) 4 in. diam., for 126590.....
126589	-----	Under Driver Pulley (flat) 5 in. diam., for 126590.....
126590	-----	Under Driver Transmitter (belt tightener) complete for 126740, Nos. 40083, 55767, 123183, 126169, 126179, 126572, 126573, 126575, 126577, 126580, 126583, 126584, 126586, 126588, 126791, 126792, 127000, two each 1796E, 126585 and three wood screws 1 3/4 in. No. 16.
126611	7880	Brace (table) with 1 1/4 in. No. 12 F.H.B. wood screw, for 126616 and 126618 to 126620.....
126612	-----	Table Clamp Bolt 51092P with 126079 and 126501, for attaching tables to new steel work (Accessories).....
126616	-----	Steel Work complete for 29707, 29708 and 29712, two each Nos. 126514 and 126611.....
126618	-----	Steel Work complete for 29710, Nos. 27018, 41161, 126736, 126737, 126740, pulley (solid) 10 in. diam., 2 in. face, 1 3/16 in. bore, two each 1588R, 25446, 27108, 126505, 126514, 126611, 126734, 126735, five feet of 1 3/16 in. shafting and four feet nine inches of 1 in. flat belting.....
126619	-----	Steel Work complete for 29711 with S.D.A., Nos. 27018, pulley (solid) 10 in. diam., 3 in. face, 1 3/16 in. bore, two each 27108, 120505, 126514, 126611, five feet of 1 3/16 in. shafting and nine feet of 1 in. flat belting.....

From the Library of Diamond Needs Corp

10A134

NUMERICAL LIST OF PARTS

No.	Plate	Name
126620	-----	Steel Work complete for 29711 for S.A. 5410 Motor, Nos. 27061, two each 27108, 126505, 126514, 126611, four feet two inches of 1 3/16 in. shafting and thirteen feet of 1 in. flat belt- ing.....
126734	7874	Under Driver Treadle Support Bracket with two 362C, for 126618.....
126735	7880	Under Driver Treadle Support Bracket Rod, 25 7/8 in. long, for 126618.....
126736	7880	Under Driver Treadle Support Rod, 45 3/16 in. long, for 126618.....
126737	7880	Under Driver Treadle Support Rod Tube, 43 1/4 in. long, for 126618.....
126739	-----	Under Driver Treadle and Pitman complete for 126740, Nos. 60626, 234377 and 234381.....
126740	-----	Under Driver (belt tightener) lever pressure (right hand) one speed, flat pulley, complete, for 126618, Nos. 11864, 126590 and 126739.....
*126756	7877	Under Driver Driving Pulley Shaft for 126576.....
126757	-----	Under Driver Driving Pulley Shaft Oiling Leather Clip for 126578.....
126791	22797	Under Driver Brake Lever with 50058R, 51067C and two 60823, for 126590....
126792	22797	Under Driver Lever (compression) and Dress Guard with 200524C, 204117 and two 202845, for 126590.....
126895	22796	Under Driver Driving Pulley Spring for 126169.....
126957	-----	Journal Box Hanger Bracket 126504 with 839R, 12620, 51057R and 126509, for 126505.....
127000	22796	Under Driver Brake Lever Separating Washer for 126590.....
150208	22796	Driving Attachment Treadle Pitman Rod (lower) Spring for 27640.....
200524C	7978	Under Driver Lever (compression) and Dress Guard Set Screw for 126792 and 227970.....
201480C	7873	Under Driver Treadle Crank Set Screw for 234381.....
201480C	7873	Under Driver Treadle Set Screw for 234377.....
202845	7978	Under Driver Lever Compression Plate Rivet for 126792 and 227970.....
204100	7979	Under Driver Friction Pulley Ball Bearing Cap for 227553.....

NUMERICAL LIST OF PARTS

No.	Plate	Name
204101	7979	Under Driver Friction Pulley Ball Cap for 227553.....
204102	7979	Under Driver Friction Pulley Ball Re- taining Spring for 227553.....
204107	7979	Under Driver Driving Pulley Shaft Ball Cup for 126576.....
204108	7979	Under Driver Driving Pulley Shaft Ball Cup Cap for 126576.....
204113	7978	Under Driver Driving Pulley Shaft Thin- ble for 126590.....
204117	7979	Under Driver Lever Compression Plate for 126792 and 227970.....
227553	-----	Under Driver Friction Pulley Ball com- plete for 126179, Nos. 204100 to 204102 and thirteen 25362.....
227970	7877	Under Driver Lever (compression) and Dress Guard with 204117 and two each 200524C and 202845, obsolete, super- seded by 126792, not interchangeable
234377	7878	Under Driver Treadle with 201480C and 350231C, for 126739.....
234381	7876	Under Driver Treadle Crank with 201480C and 350231C, for 126739.....
350231C	-----	Under Driver Treadle Crank Position Screw for 234381.....
350231C	-----	Under Driver Treadle Position Screw for 234377.....

PLATE 850—ONE-HALF SIZE

SINGER Needles should be used
in SINGER Machines.
These Needles and their Containers
are marked with the
Company's Trade Mark "SIMANCO."** 1

Needles in Containers marked
"FOR SINGER MACHINES"
are NOT **SINGER** made needles. 2

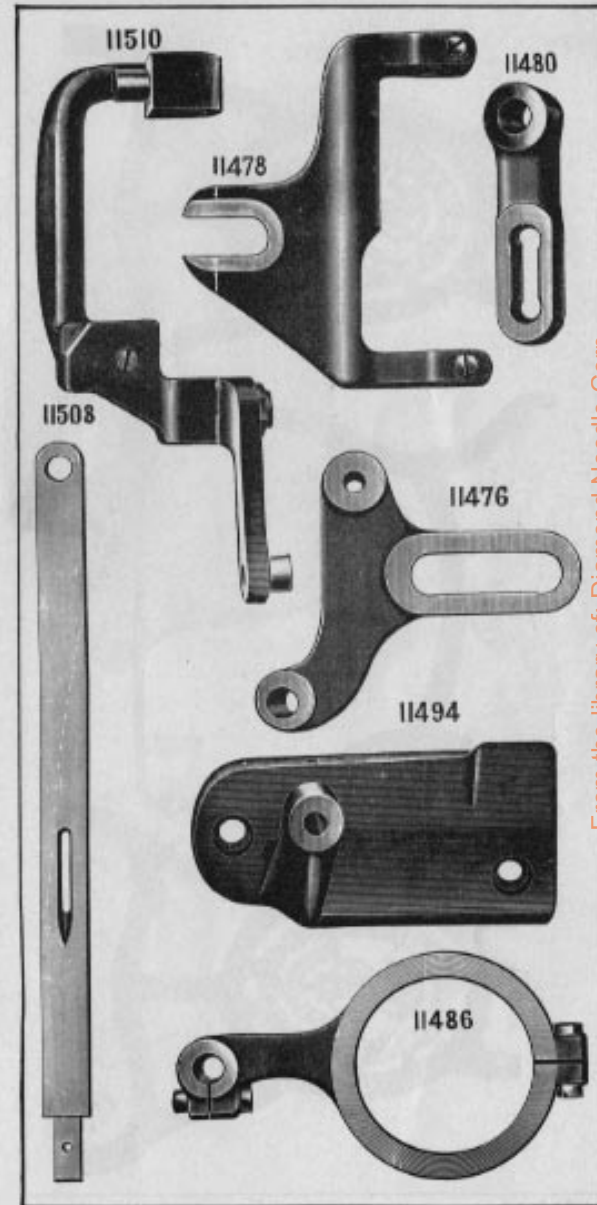

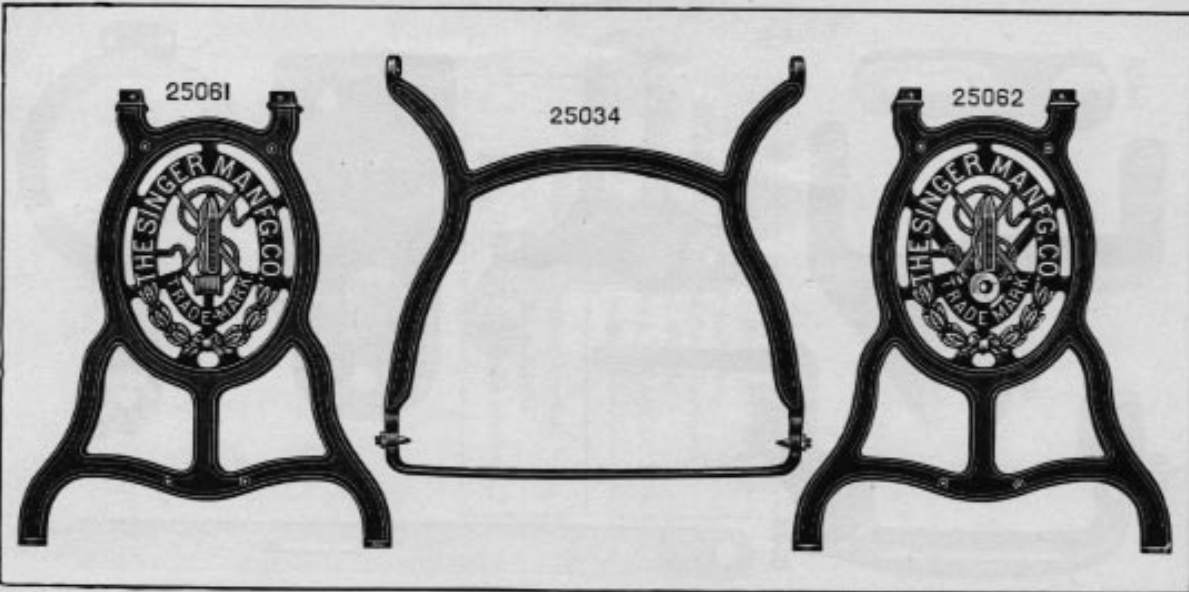

PLATE 1860—ONE-NINTH SIZE

PLATE 3563—FULL SIZE

49844-58669



16901

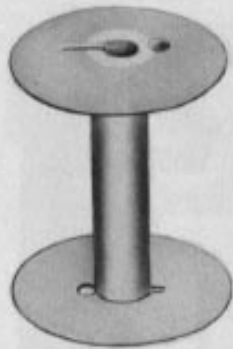

PLATE 3564—FULL SIZE

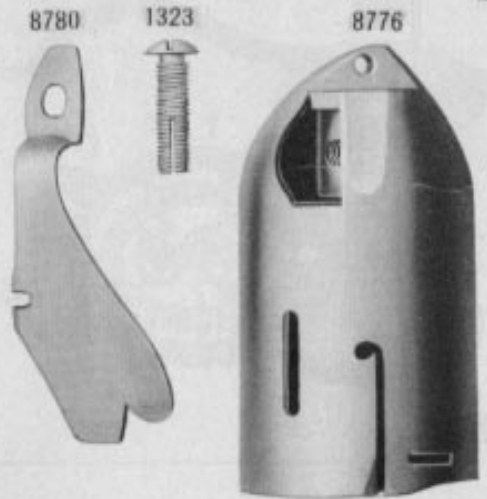
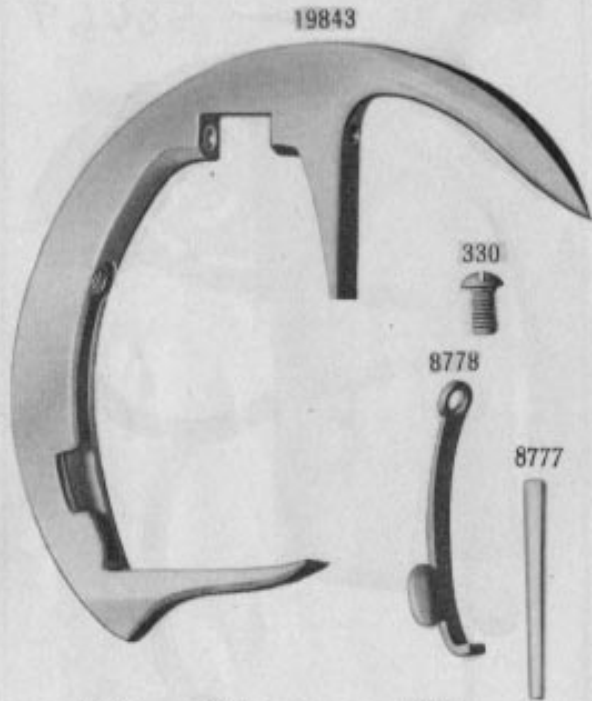

PLATE 4436—FULL SIZE

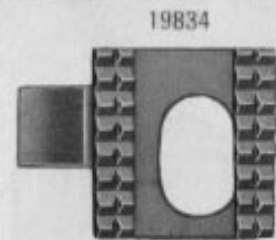
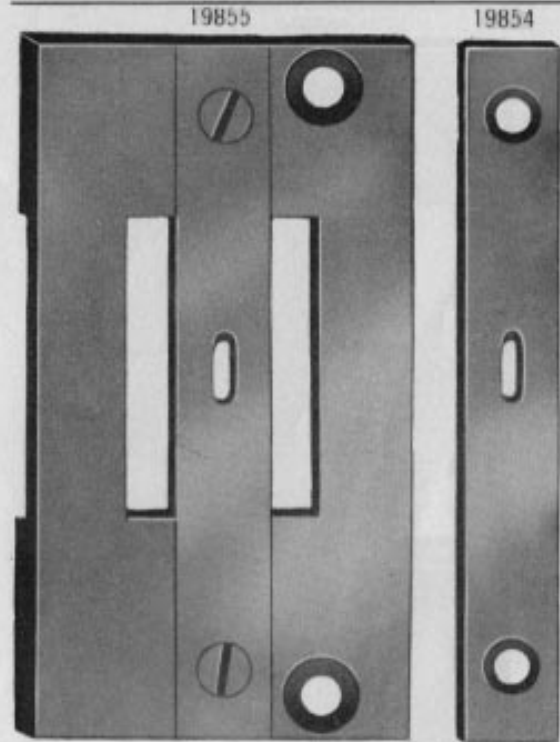
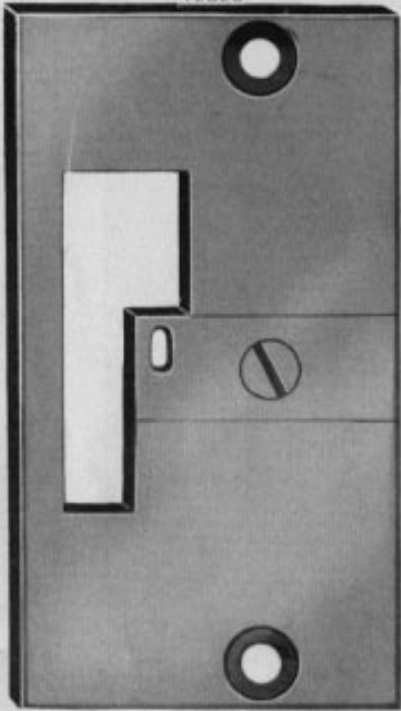
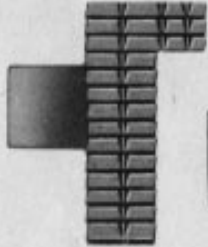

PLATE 4437—FULL SIZE

19858



19835



19857



PLATE 4441—ONE-HALF SIZE

19849



19846



19847



PLATE 4456—ONE-HALF SIZE

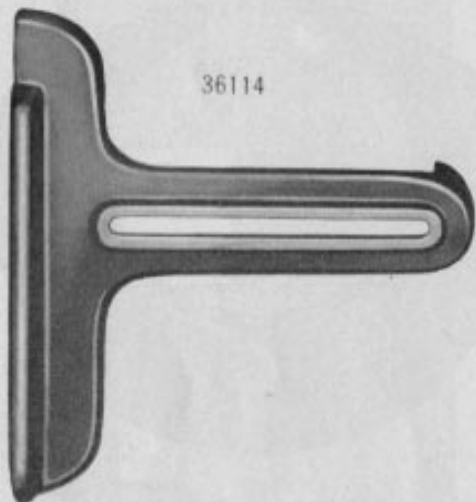

36114

PLATE 4459—ONE-NINTH SIZE

25094



25093

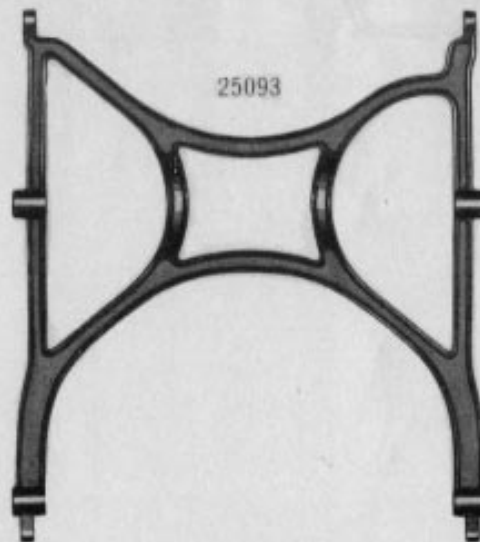

PLATE 4460—ONE-NINTH SIZE

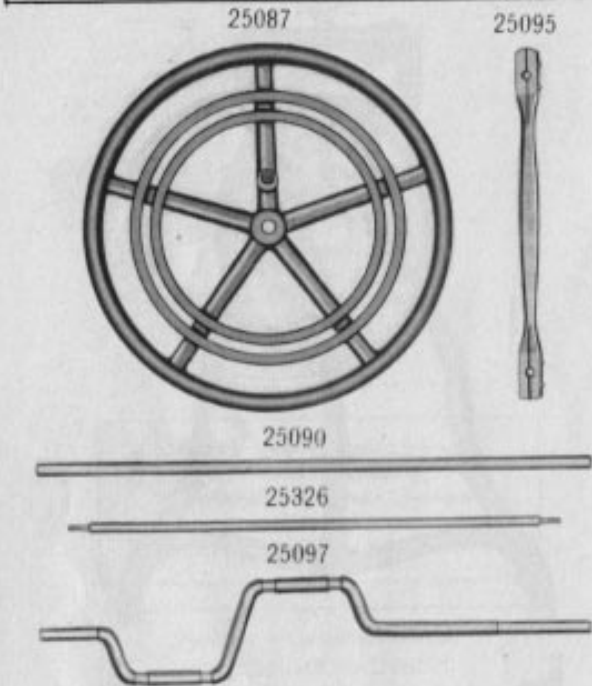

PLATE 4461—ONE-FOURTH SIZE

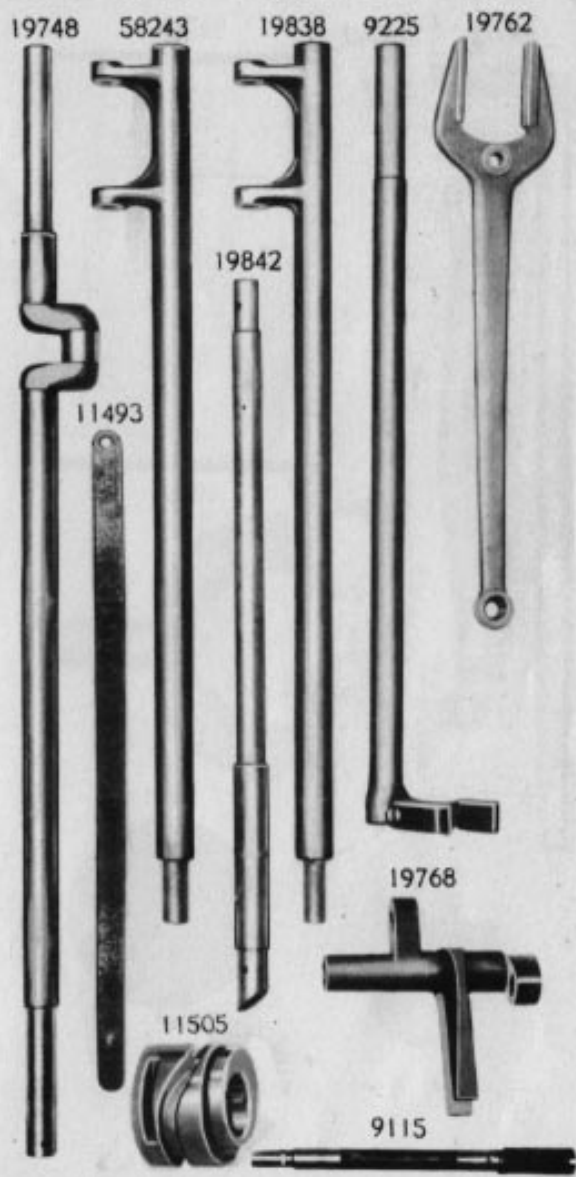

PLATE 4462—ONE-FOURTH SIZE

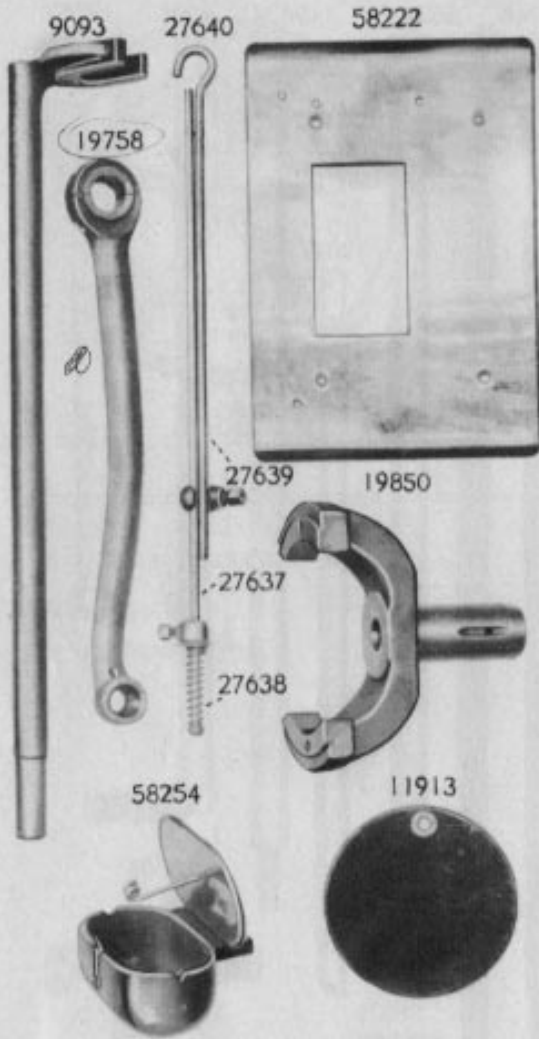
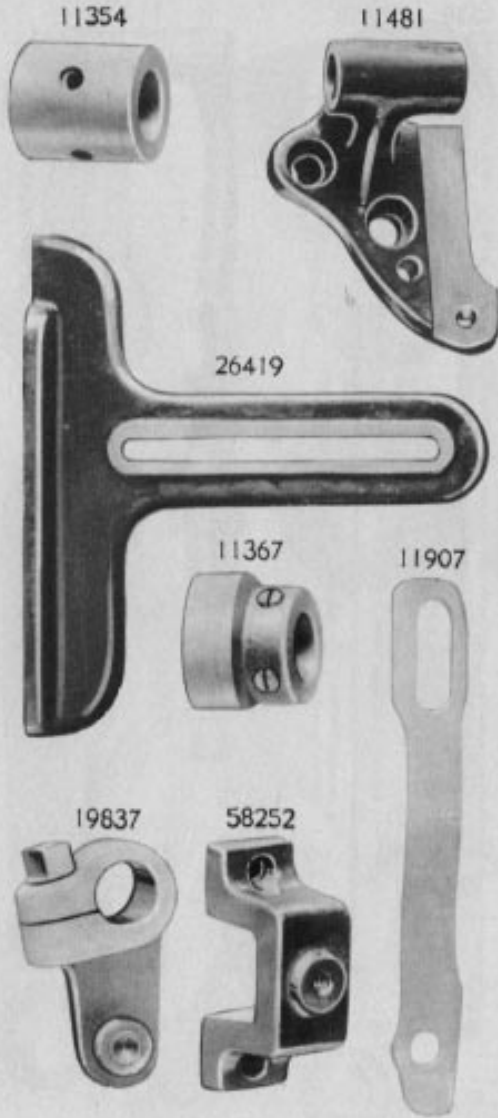

PLATE 4463—ONE-HALF SIZE



From the library of: Diamond Needle Corp

10-2781

PLATE 4464—ONE-HALF SIZE

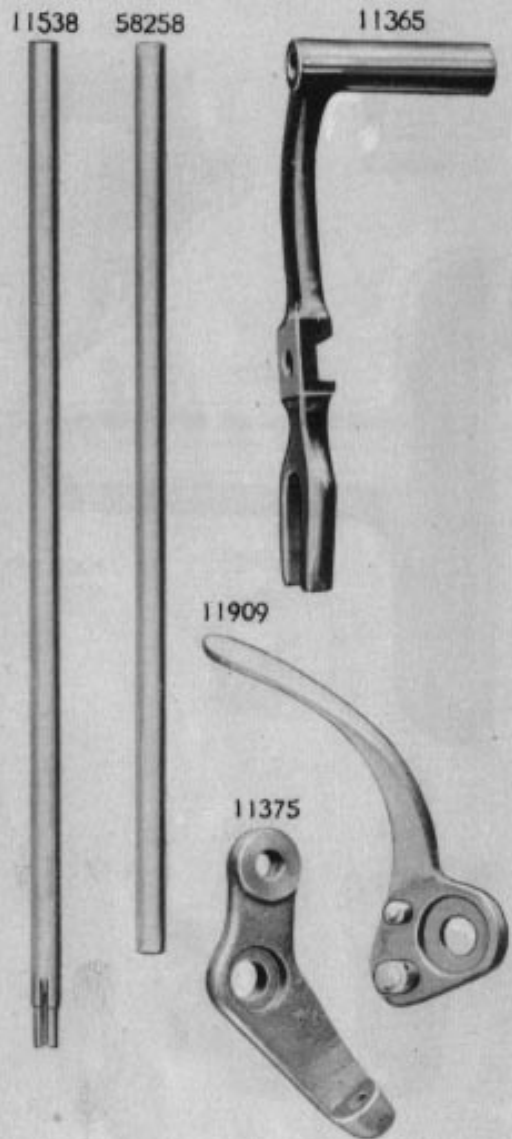
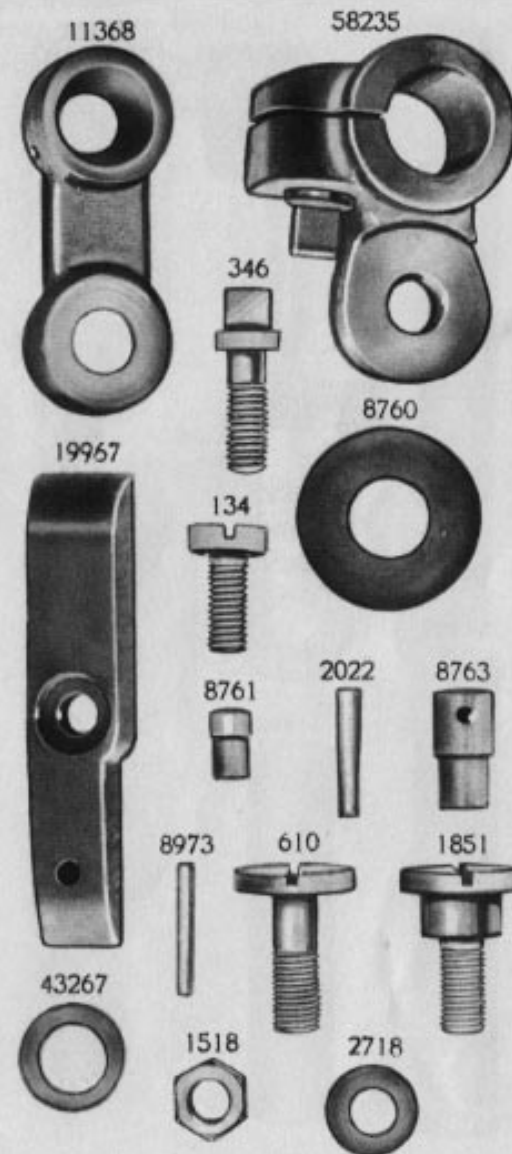

PLATE 4465—FULL SIZE



2182

PLATE 4466—FULL SIZE

11479



11484



1850



453



608



58259



11487



11489



11490



11488



11492



PLATE 4467—FULL SIZE

19860

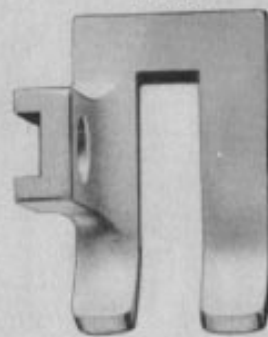

58260



58262

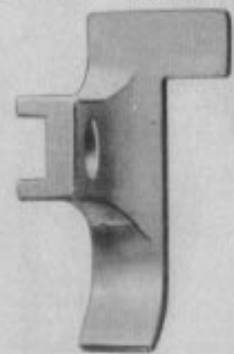

58261



From the library of: Diamond Needle Corp

PLATE 4468—FULL SIZE

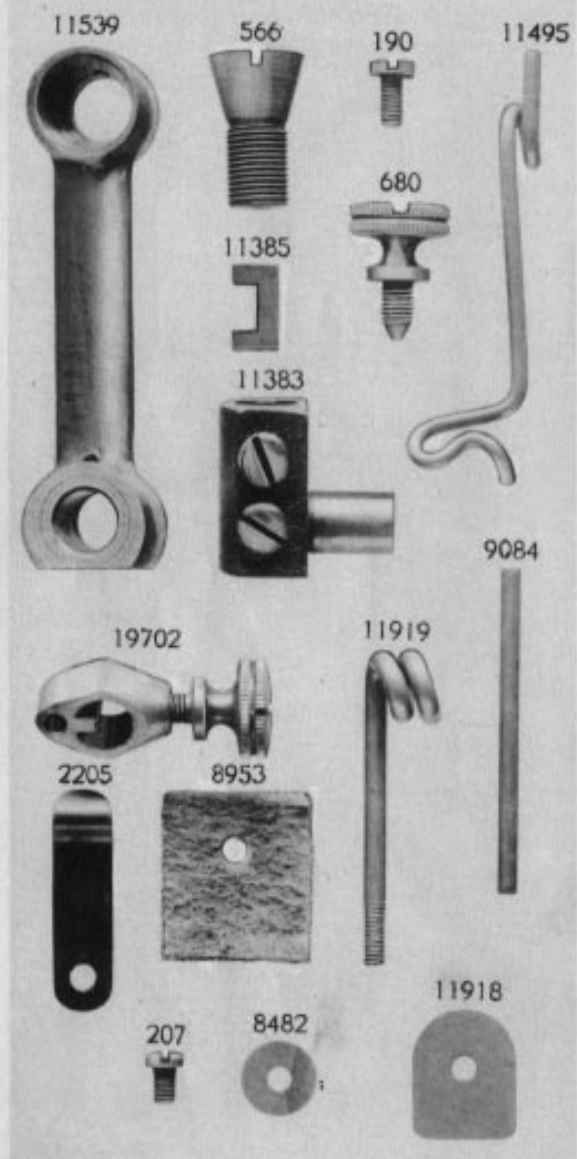
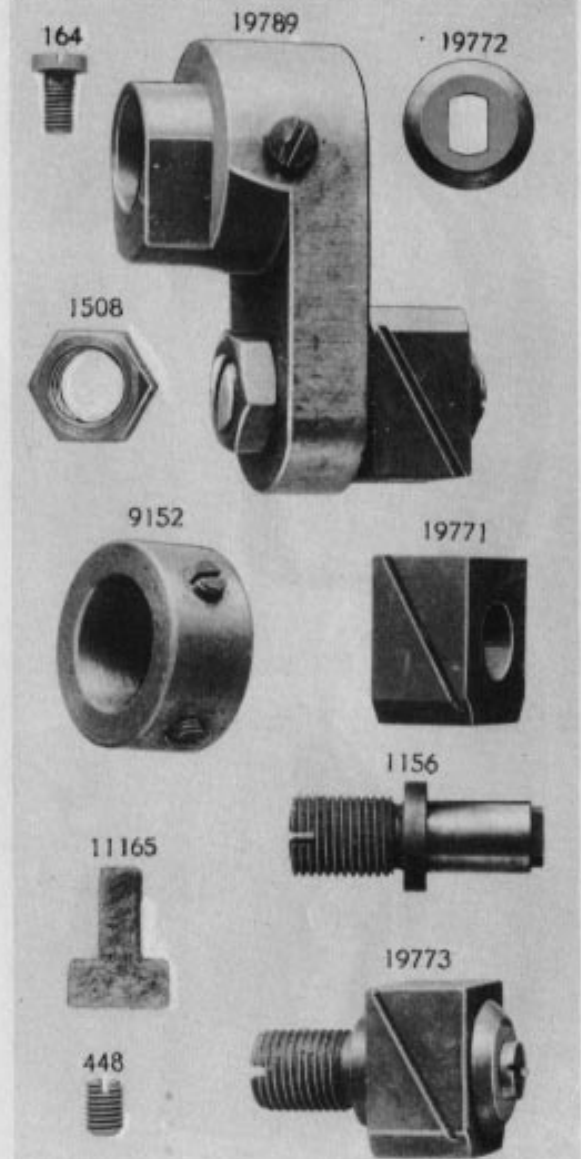

PLATE 4469—FULL SIZE



From the library of: Diamond Needle Corp

PLATE 4470—FULL SIZE

58208



58207

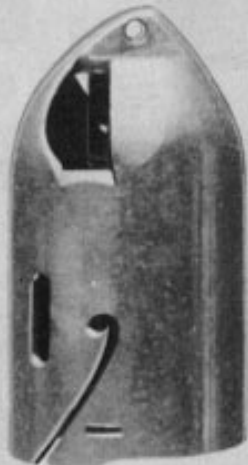
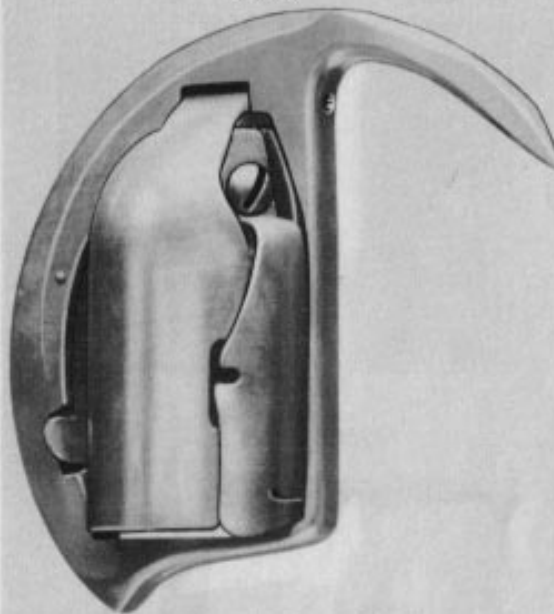

PLATE 4471—FULL SIZE

58210



58209



43235



43236



19869



PLATE 4472—ONE-HALF SIZE

9121



9122



58256

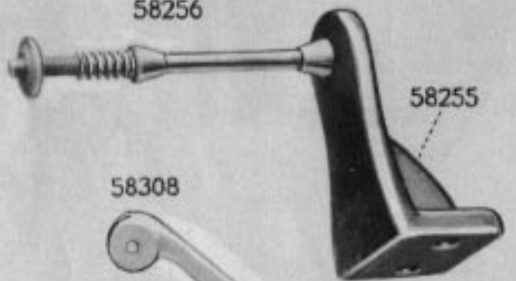

58255

58308



19845

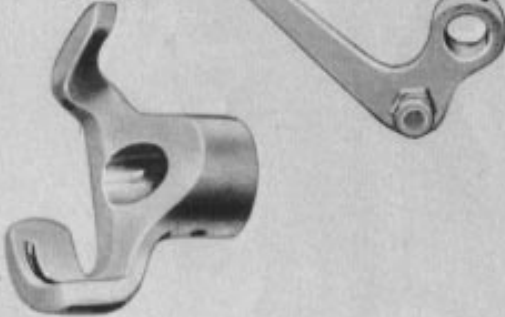

PLATE 4473—FULL SIZE

145



159



11502

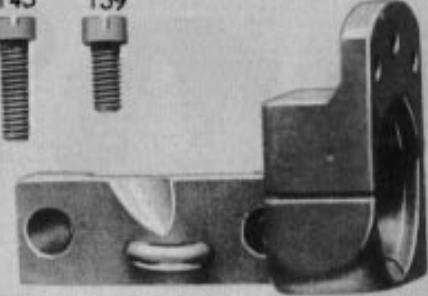

851



8018



5983

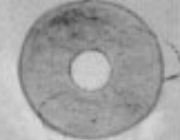

8019



607



122



1541



8905



11423

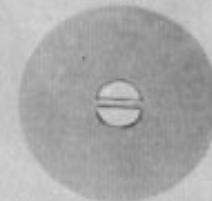

1560



From the library of: Diamond Needle Corp

PLATE 4474—FULL SIZE

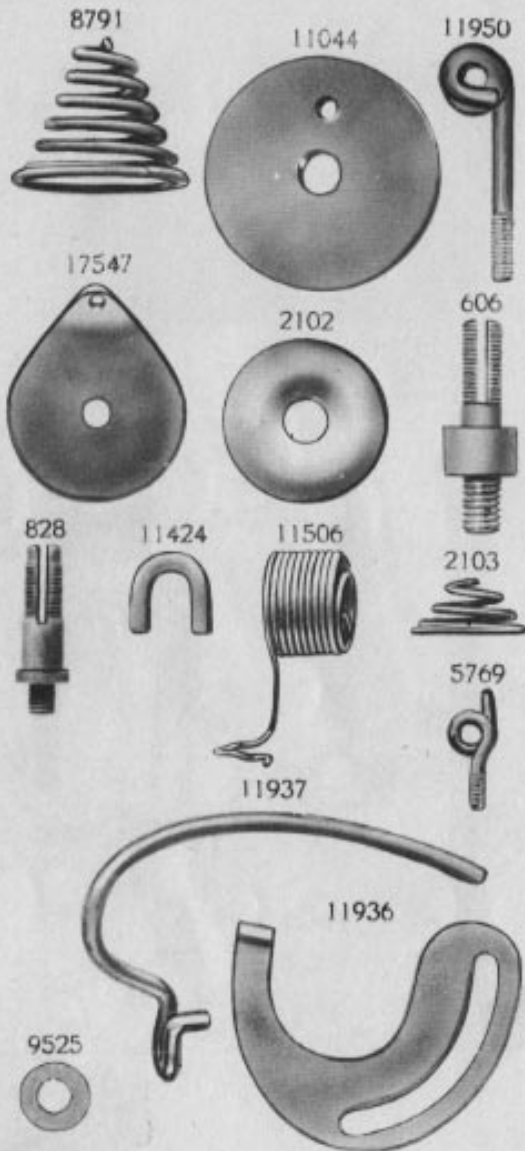

PLATE 4475—FULL SIZE

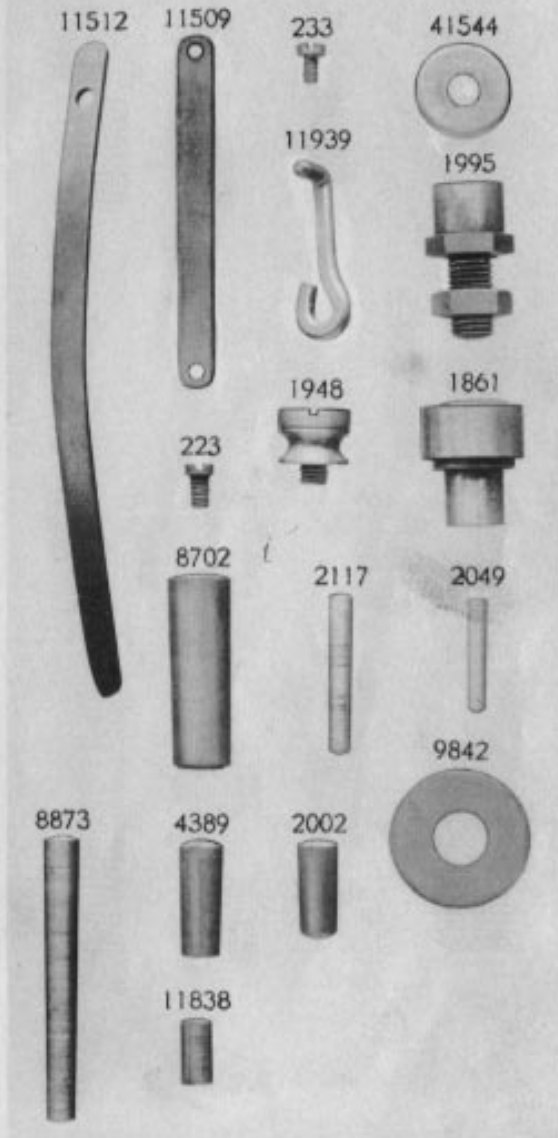

PLATE 4476—FULL SIZE

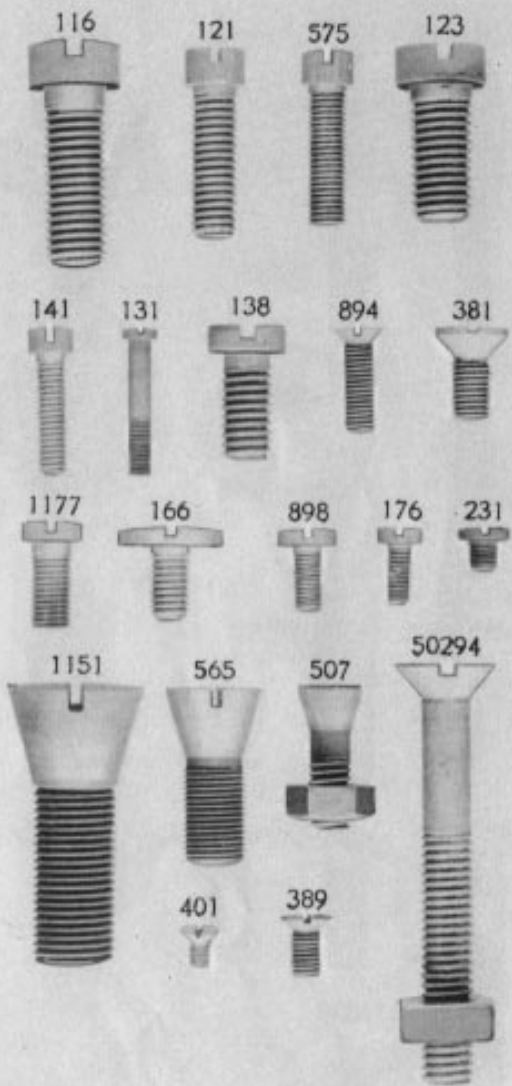
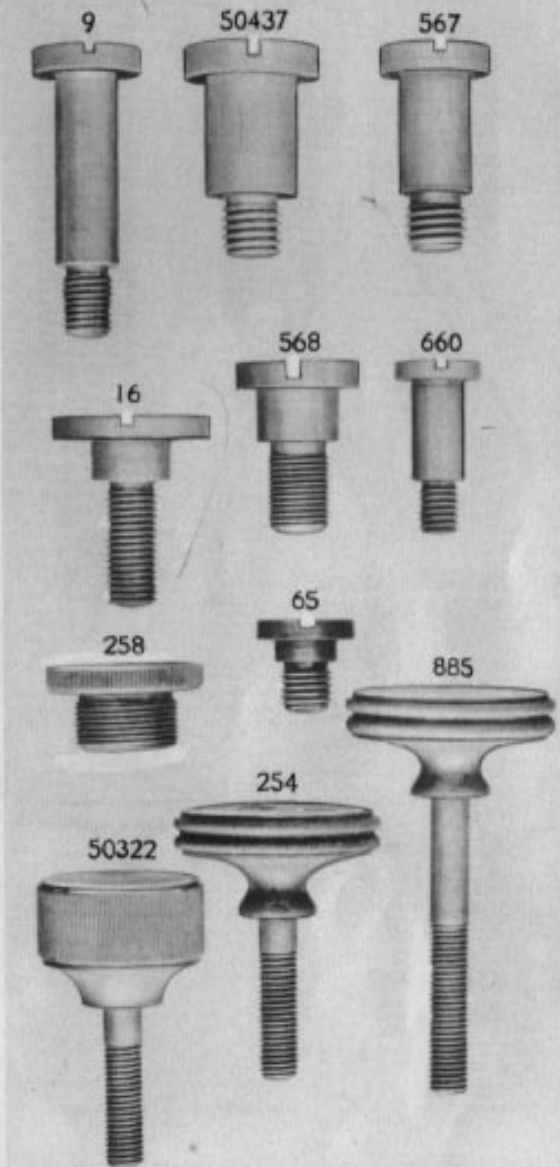

PLATE 4477—FULL SIZE



From the library of: Diamond Needle Corp

PLATE 4478—FULL SIZE

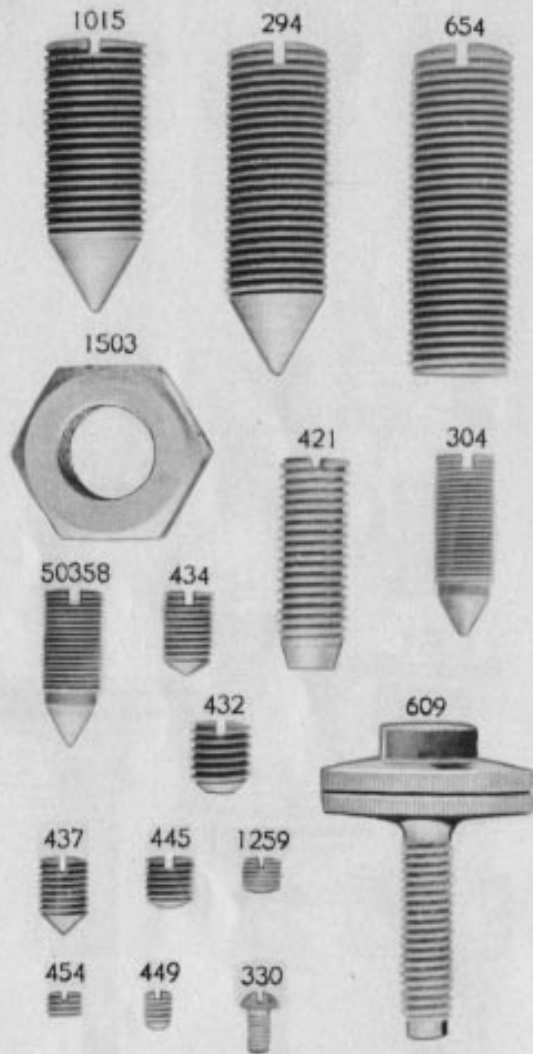

PLATE 4479—FULL SIZE



From the library of: Diamond Needle Corp

PLATE 4480—ONE-NINTH SIZE

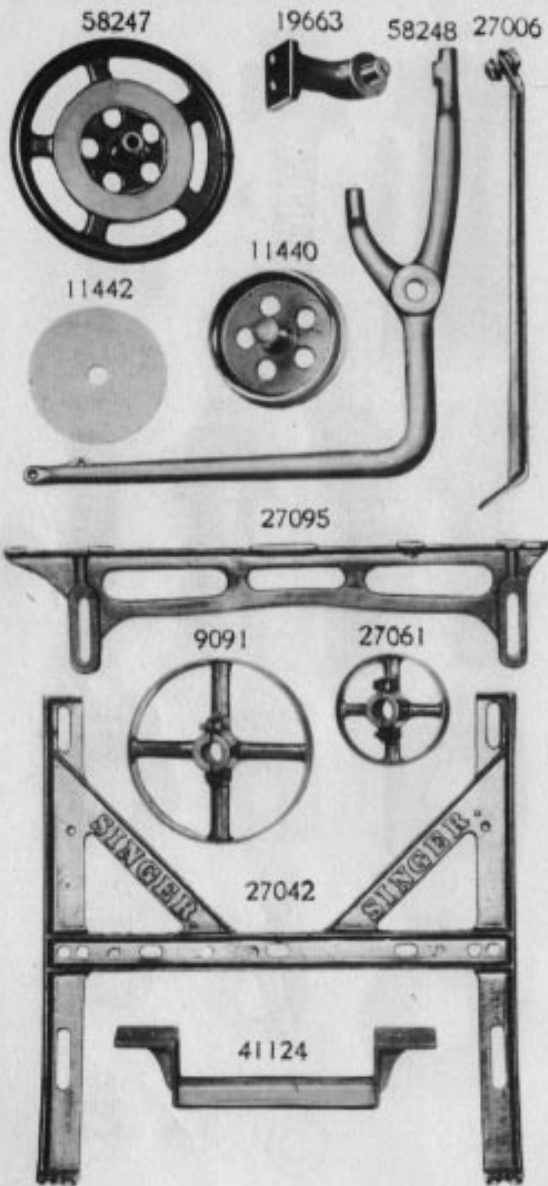

PLATE 4481—ONE-FOURTH SIZE

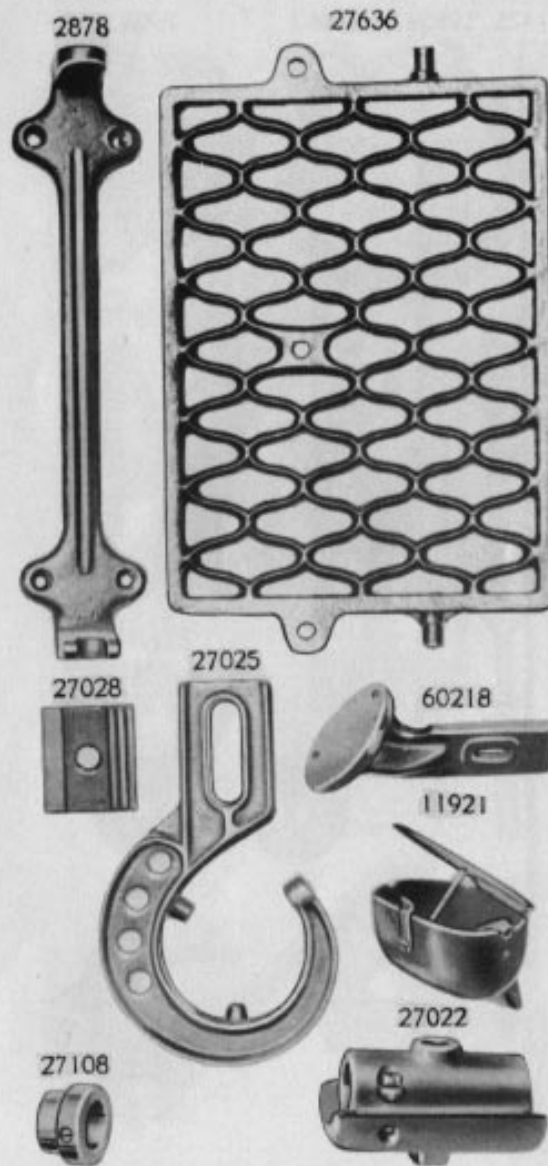

PLATE 4482—ONE-HALF SIZE

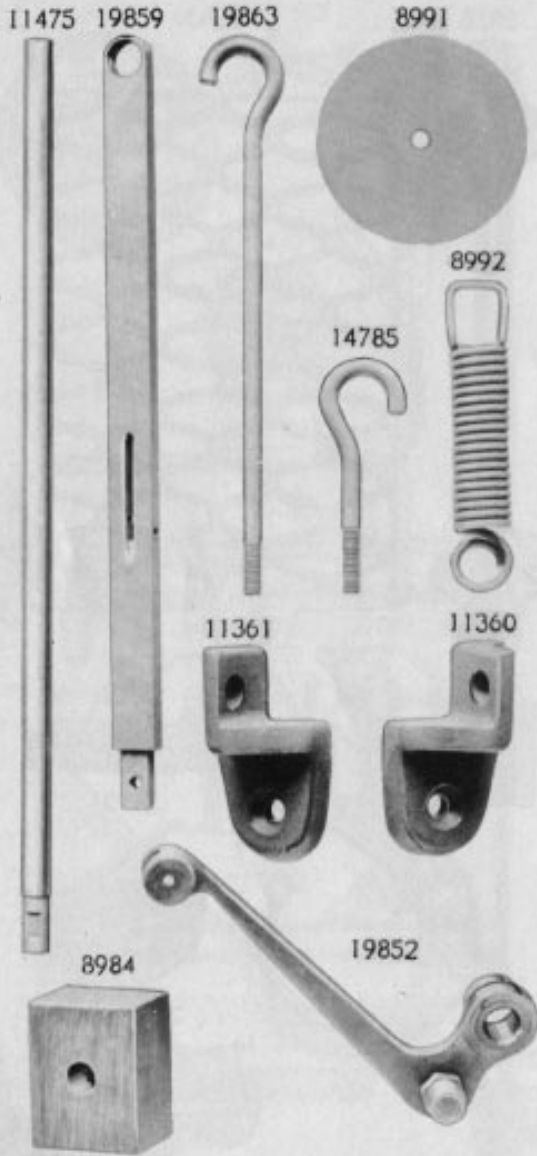

PLATE 4483—FULL SIZE



From the library of: Diamond Needle Corp

PLATE 4484—ONE-HALF SIZE

23535 120344 8909 26026 11831



PLATE 4485—ONE-HALF SIZE

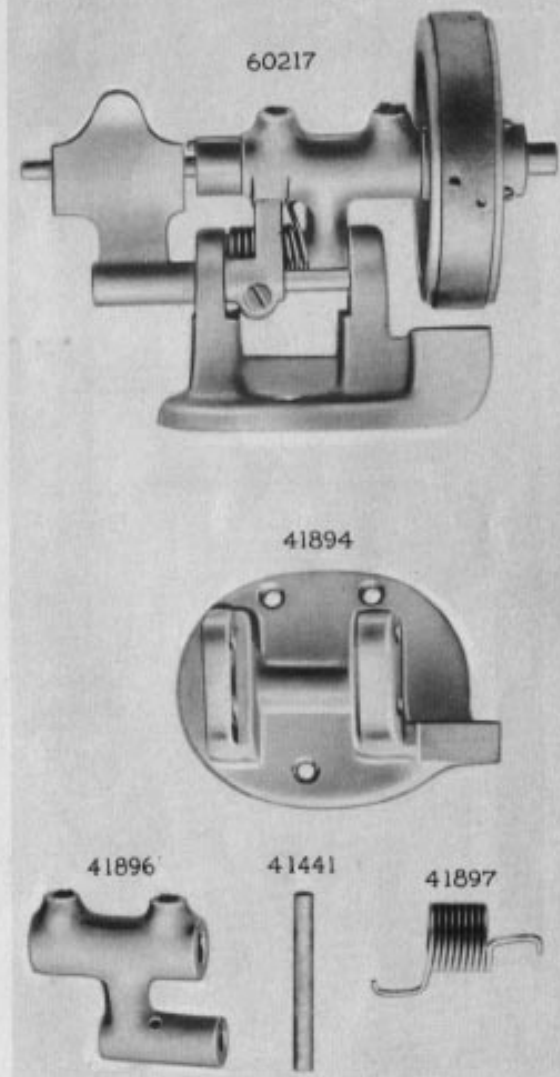

PLATE 4486—ONE-HALF SIZE

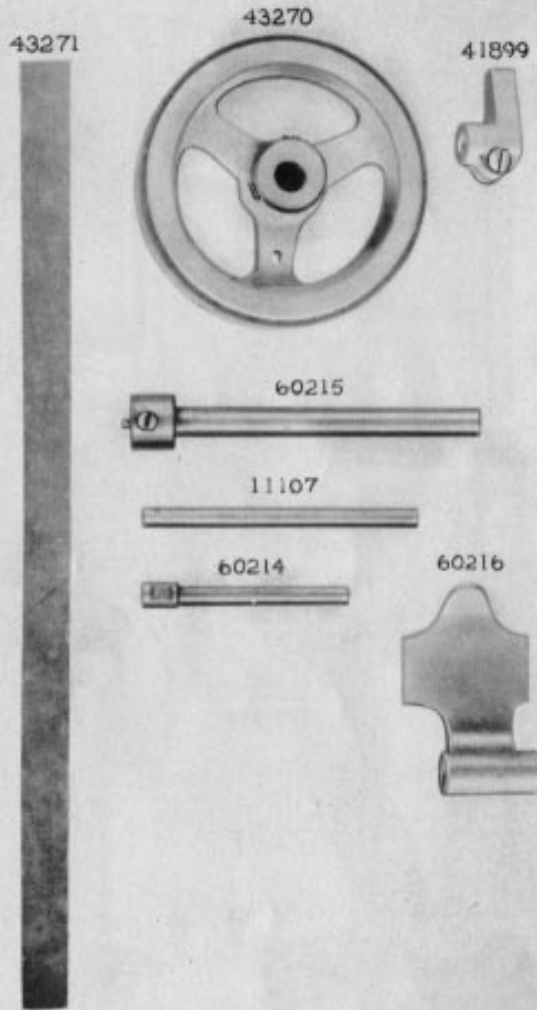
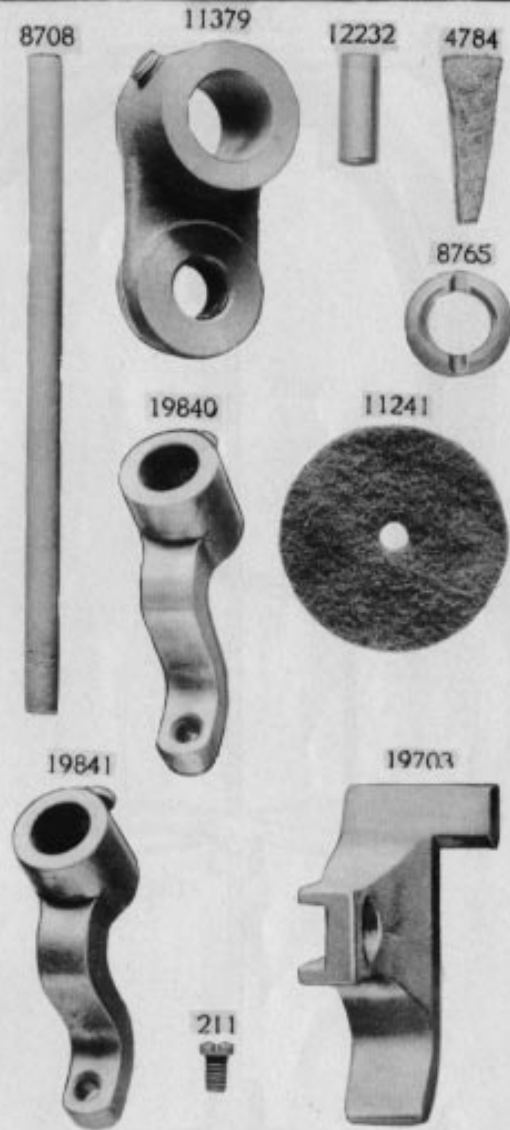

PLATE 4487—FULL SIZE



From the library of: Diamond Needle Corp

PLATE 4488—FULL SIZE

19975



PLATE 7285—ONE-FOURTH SIZE

41823

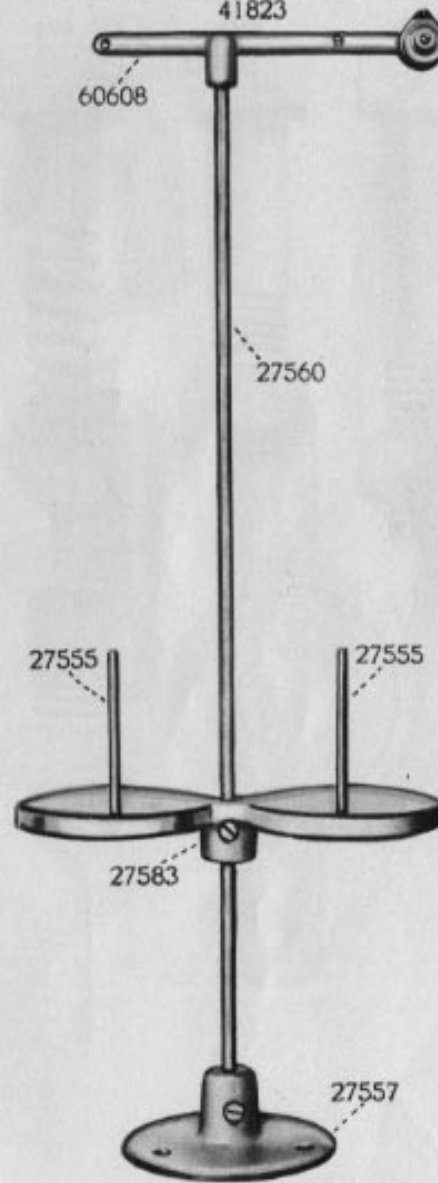

From the library of: Diamond Needle Corp

PLATE 7288—FULL SIZE

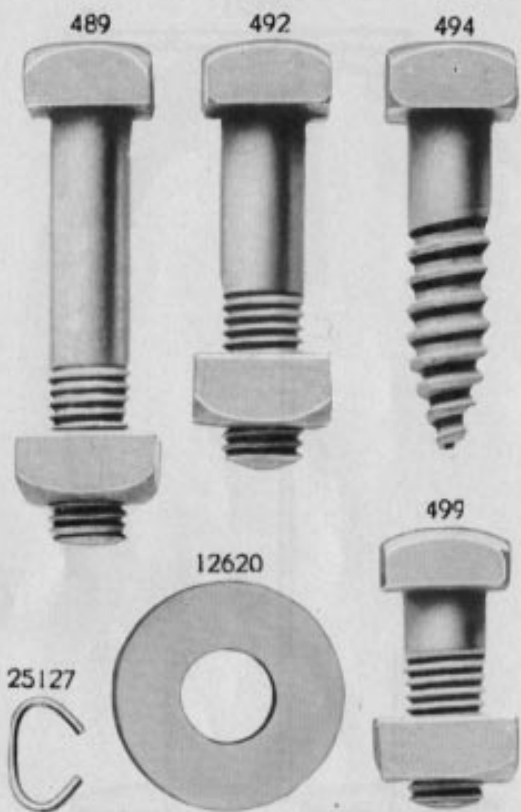

PLATE 7870—ONE-HALF SIZE

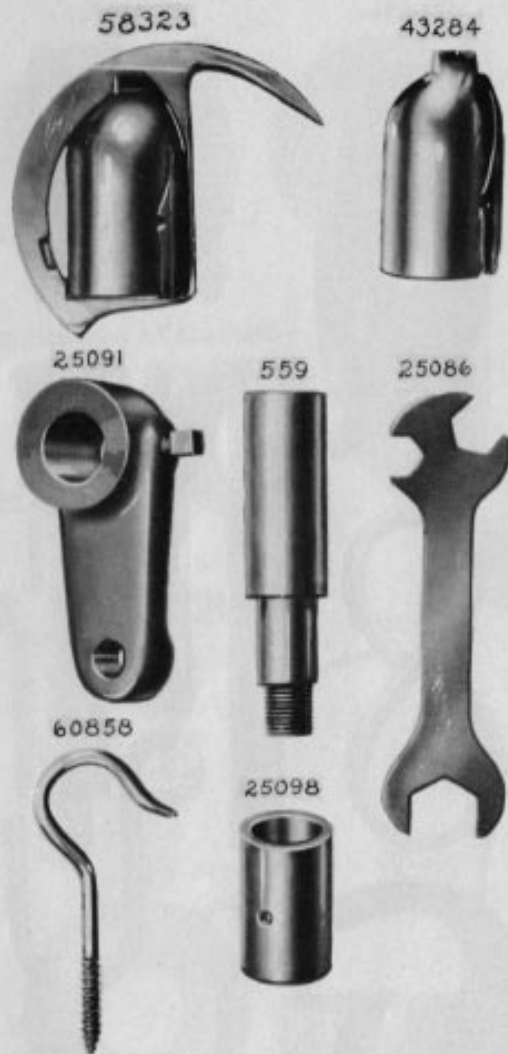

PLATE 7871—FULL SIZE

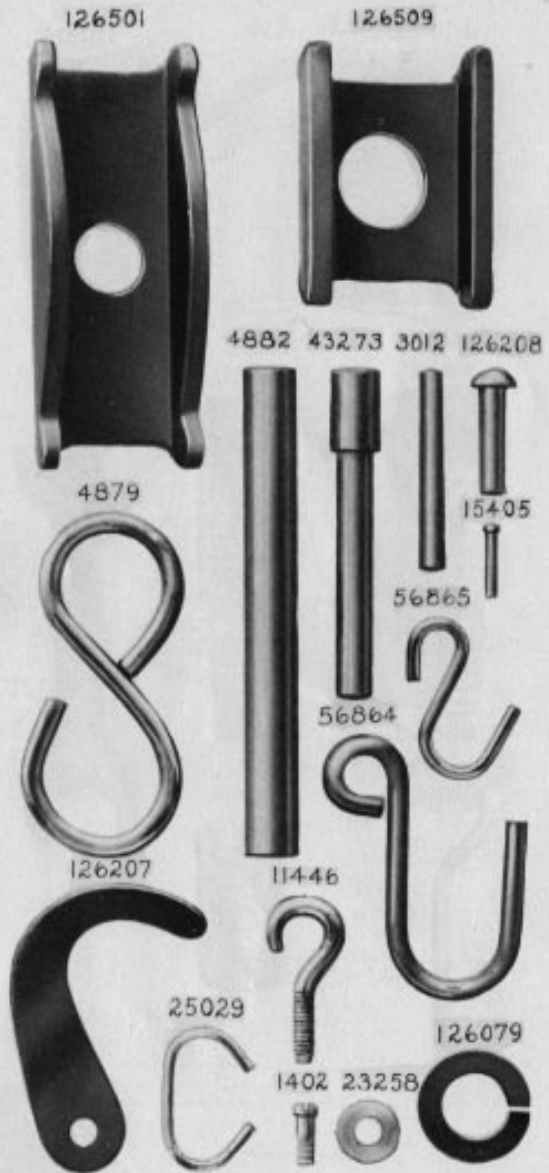

PLATE 7872—FULL SIZE



From the library of: Diamond Needle Corp

PLATE 7873—FULL SIZE

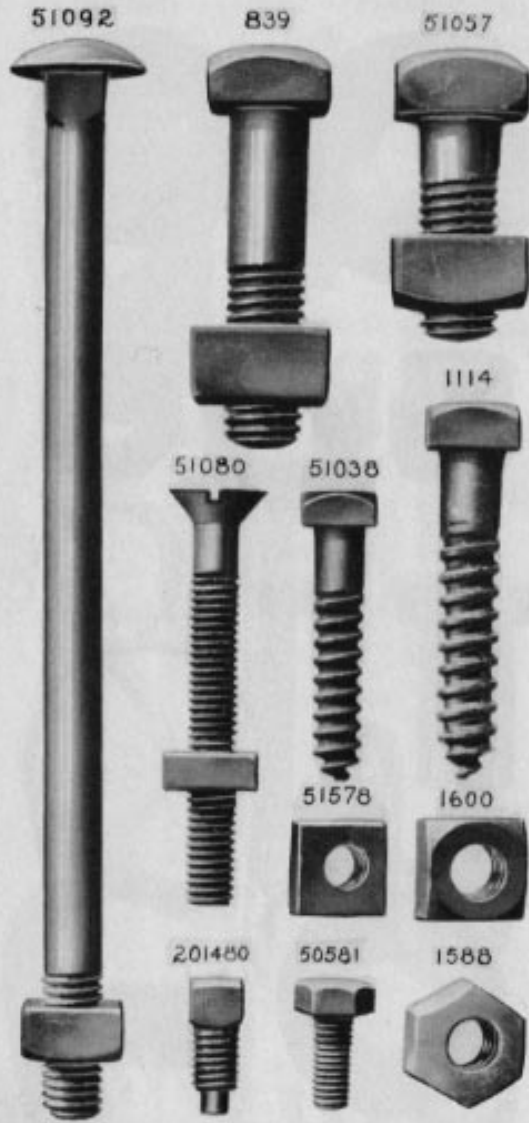
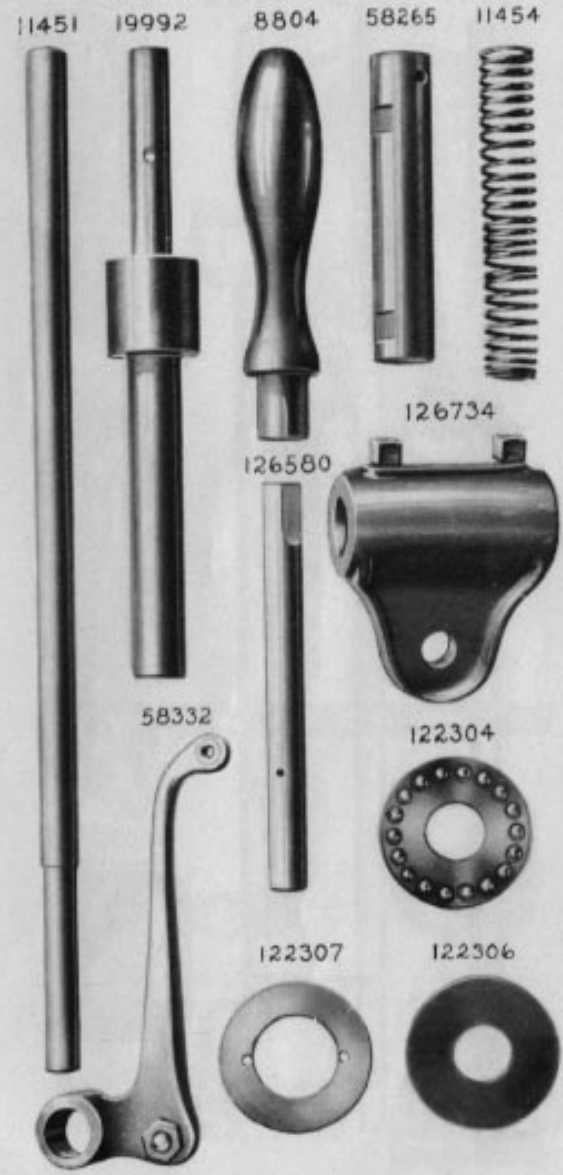

PLATE 7874—ONE-HALF SIZE



From the library of: Diamond Needle Corp

PLATE 7875—ONE-FOURTH SIZE

19747 58334 19923 60626

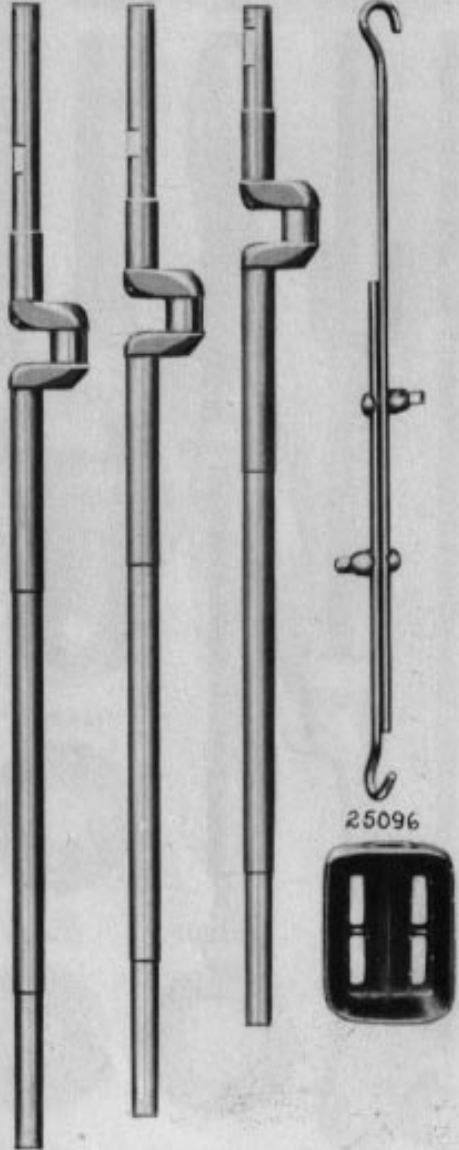
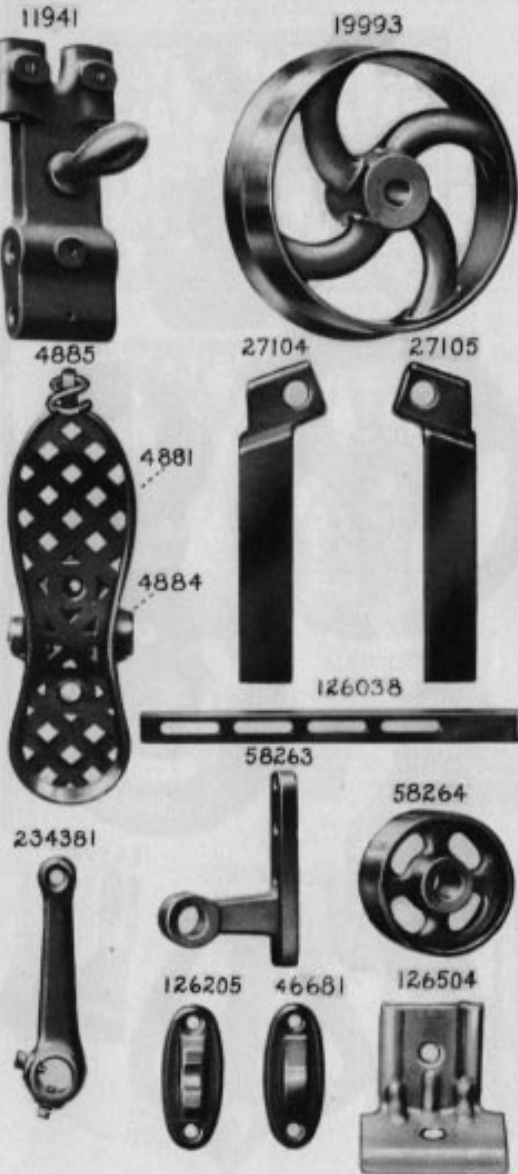

PLATE 7876—ONE-FOURTH SIZE



From the library of: Diamond Needle Corp

PLATE 7877—ONE-FOURTH SIZE



PLATE 7878—ONE-SIXTH SIZE

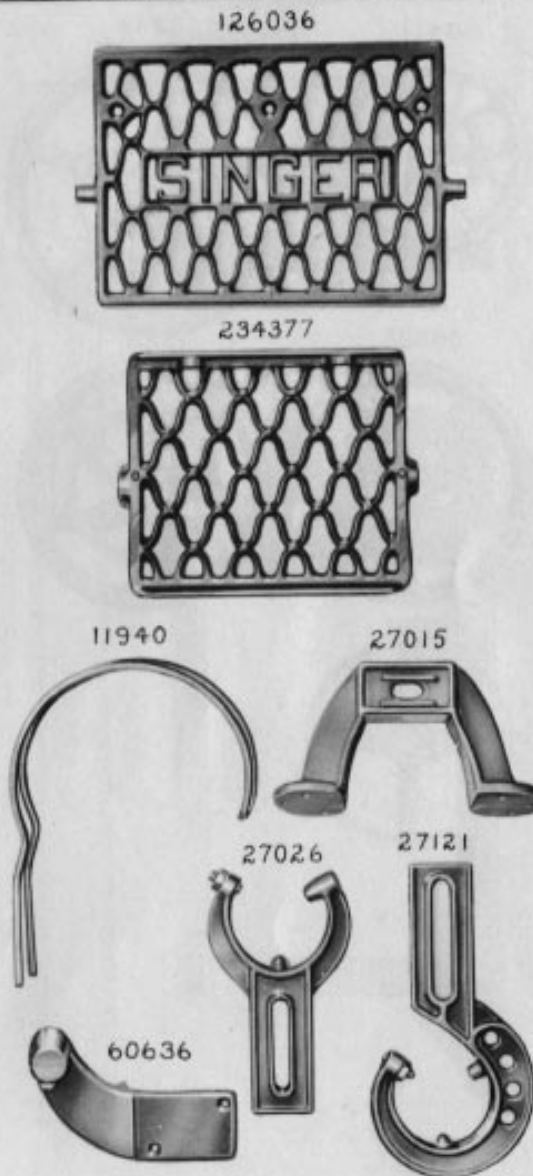

PLATE 7879—ONE-EIGHTH SIZE

58411



58249



58335



19991



11864



PLATE 7880—ONE-NINTH SIZE

126735 126611 126508



126516



126512



126736

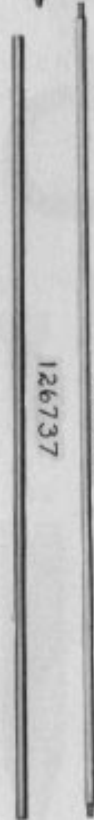

126737

From the library of: [Diamond Needle Corp](#)

PLATE 7881—FULL SIZE



PLATE 7882—ONE-EIGHTH SIZE

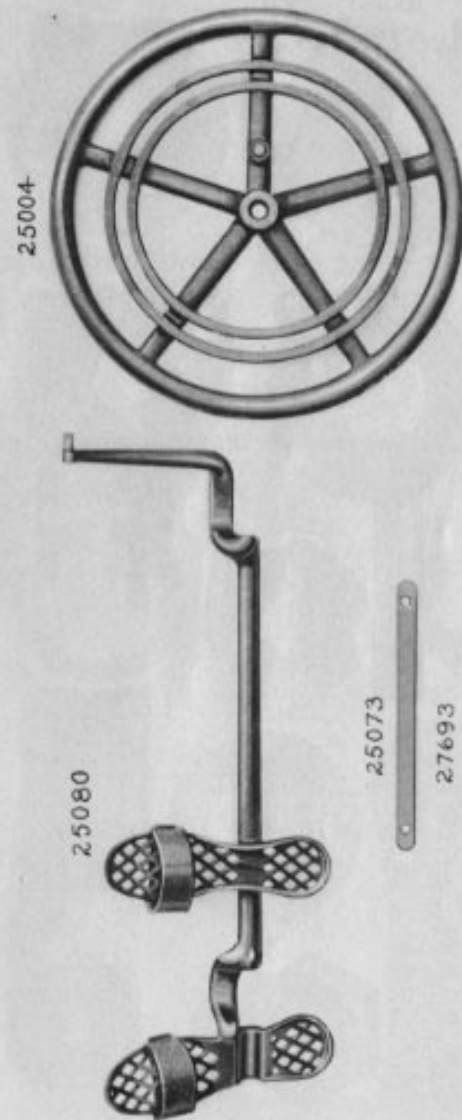

From the library of: Diamond Needle Corp

PLATE 7978—FULL SIZE

51068 50959 50512 200524 51067



25362 25303 126175 50058 50288



126173



55767 27414 126203 123183 202845



126573



60935



204113

1595



1796



51541



PLATE 7979—FULL SIZE

204108

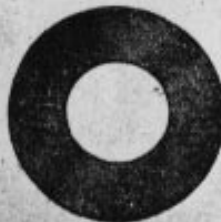

12620



204100



204107



204102



204101



126585



204117



126201



227555



9252



From the library of: Diamond Needle Corp

PLATE 7980—ONE-HALF SIZE

126572 126584 126575 126578

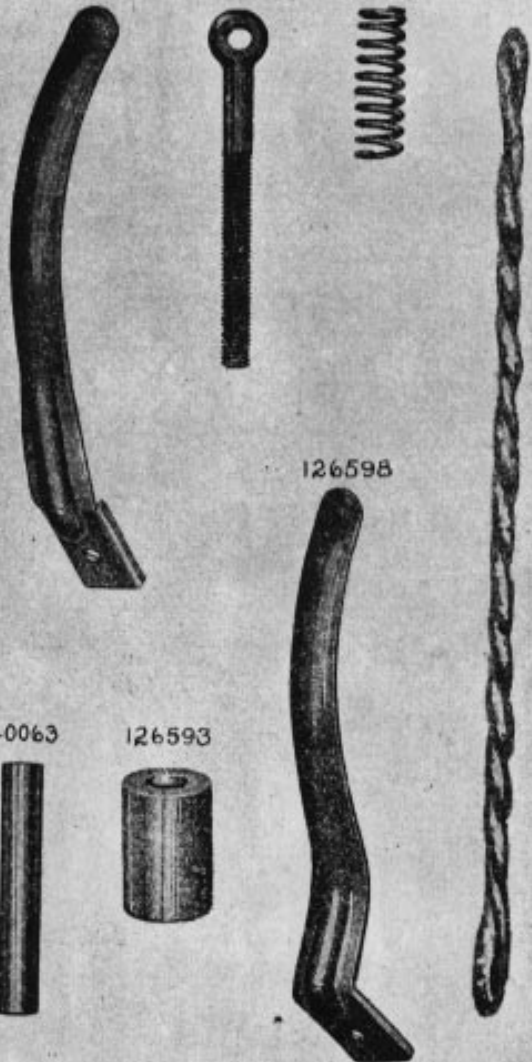
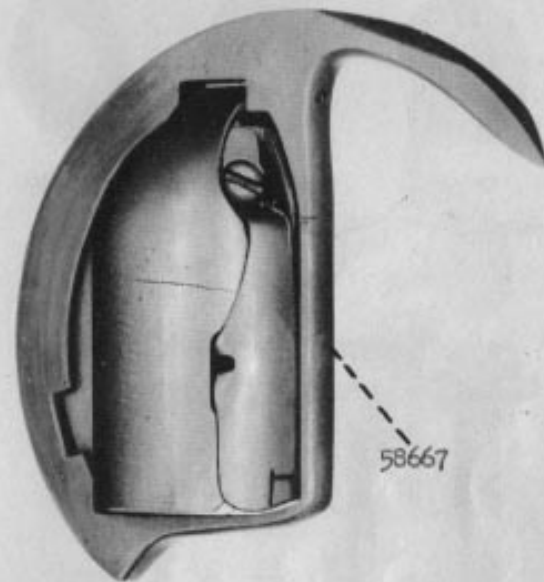

PLATE 22795 - FULL SIZE

58669



120571



58666



58664



From the library of: Diamond Needle Corp

PLATE 22796 - ONE-HALF SIZE



PLATE 22797 - ONE FOURTH SIZE



From the library of: Diamond Needle Corp

PLATE 22798 - ONE- NINTH SIZE

58587



58563



58619



58648



58653



58654

58657



58159
4384

